



Model 240

Operating Manual



ABOUT THIS MANUAL

READ THIS OPERATING MANUAL BEFORE ATTEMPTING TO USE THE INSTRUMENT.

This manual is valid for the Model 240 (applies from firmware version 4v47 onwards – please refer to section 1.3).

Amplivox Ltd.
10393 West 70th Street
Eden Prairie
MN 55344
United States

This product is manufactured by:

Amplivox Ltd.
3800 Parkside, Solihull Parkway,
Birmingham Business Park,
Birmingham, West Midlands,
B37 7YG
United Kingdom
www.amplivox.com

Tel: 888 941 4208
Fax: 952 903 4100
info@amplivox.us

For all enquiries please contact us under:

Tel: +44 (0)1865 880846

hello@amplivox.com



For supply in US only

Caution: Federal Law restricts this device to sale by or on the order of a licenced medical professional.

CONTENTS

1.	INTRODUCTION	1
1.1.	INTENDED APPLICATIONS	1
1.2.	UNPACKING.....	1
1.3.	FIRMWARE VERSION.....	1
1.4.	STANDARD CONTENTS.....	1
1.5.	OPTIONAL ACCESSORIES.....	1
2.	IMPORTANT SAFETY INSTRUCTIONS.....	2
2.1.	PRECAUTIONS.....	2
2.2.	ELECTROMAGNETIC COMPATIBILITY (EMC) CONSIDERATIONS.....	2
2.3.	POWER SUPPLY OPTIONS.....	2
2.4.	AUDIOMETER CONNECTIONS	3
2.5.	DATA TRANSFER TO A PRINTER	4
2.6.	DATA TRANSFER TO A COMPUTER	4
3.	USING THE AUDIOMETER	5
3.1.	SWITCHING THE AUDIOMETER ON AND OFF.....	5
3.2.	TESTING THE PATIENT RESPONSE SWITCH	5
3.3.	AUDIOMETER DISPLAY	5
3.4.	AUDIOMETER CONTROLS.....	5
3.5.	THRESHOLD RETENTION FUNCTION	7
3.6.	SAVING AUDIOGRAMS IN INTERNAL MEMORY	8
3.7.	LOADING AUDIOGRAMS FROM INTERNAL MEMORY	8
3.8.	PRINTING AUDIOGRAMS.....	8
3.9.	DATA TRANSFER TO NOAH OR AMPLISUITE	8
4.	SUGGESTED SEQUENCE OF OPERATION AND TEST PROCEDURE	9
4.1.	AUDIOMETRY PREPARATION AND AMBIENT CONDITIONS	9
4.2.	TEST SYSTEM ARRANGEMENT	9
4.3.	HEADSET	9
4.4.	MANUAL AUDIOMETRY	9
4.5.	AUTOMATIC AUDIOMETRY	10
5.	SPECIFICATION	13
5.1.	OUTPUT DATA.....	13
5.2.	MAXIMUM HEARING LEVELS PROVIDED AT EACH FREQUENCY	13
5.3.	PHYSICAL DATA	13
5.4.	EQUIPMENT CLASSIFICATION	14
6.	SYMBOLS.....	15
7.	TECHNICAL INFORMATION	16
8.	ROUTINE MAINTENANCE	17
8.1.	AUDIOMETER MAINTENANCE.....	17
8.2.	TRANSDUCER MAINTENANCE.....	17
8.3.	EARPHONES	17
8.4.	INSERT EARPHONE/MASKER.....	17
8.5.	INSERT EARPHONES	17
8.6.	MAINS ADAPTER MAINTENANCE.....	18
9.	INSTRUMENT STORAGE AND TRANSPORTATION	19
10.	CALIBRATION AND REPAIR OF THE INSTRUMENT	19
11.	GUARANTEE	20
12.	ORDERING CONSUMABLES AND ACCESSORIES	21
13.	DISPOSAL INFORMATION	22
APPENDIX 1 - EMC GUIDANCE & MANUFACTURER'S DECLARATION		23
APPENDIX 2 - USE WITH NON-MEDICAL ELECTRICAL EQUIPMENT		27

1. INTRODUCTION

Thank you for purchasing an Amplivox audiometer. The Amplivox Model 240 is a diagnostic audiometer that will vsgive many years of reliable service if treated with care.

1.1. INTENDED APPLICATIONS

The Model 240 diagnostic audiometer is designed for use by audiologists, general practitioners, hearing aid dispensers and child health professionals. It is capable of undertaking both air conduction (AC) and bone conduction (BC) tests with or without masking.

The instrument is completely portable, and if required may be specified to operate from internal batteries (see Section 2.3 below). Test results may be printed using the specified printer option or transferred to a PC running the NOAH application or Amplivox ampliSuite.

1.2. UNPACKING

Open the shipping carton and carefully remove all the equipment. Check against the delivery note that all the accessories ordered have been included with your audiometer. If anything is missing, please contact Amplivox Customer Support (+44 1865 880846; sales@amplivox.ltd.uk). If you have purchased from a distributor you should contact them directly.

Please retain the shipping carton and packing materials as the audiometer will need calibrating on an annual basis and should be returned to Amplivox in its original shipping carton.

1.3. FIRMWARE VERSION

This operating manual is for firmware versions 4v47 onwards. To check the version of firmware on your audiometer press and hold the MENU button followed by the TALKOVER button.

1.4. STANDARD CONTENTS

Model 240 Audiometer	Audiometric headset
Bone vibrator headset	Patient response switch
Mains adapter	Audiogram cards
Operating manual & ampliSuite	NOAH Audilink software
Carrying case	Calibration certificate

1.5. OPTIONAL ACCESSORIES

Battery power function	Additional audiogram cards
Masking earpiece	Insert earphones
Printer(s)	Printer cable(s)
USB Cable	
Audiocups (noise reducing earphone enclosures)	



2. IMPORTANT SAFETY INSTRUCTIONS



The Model 240 instrument must be used only by practitioners qualified to perform audiometric tests. It is intended for use as a screening and diagnostic tool.

2.1. PRECAUTIONS

READ THIS OPERATING MANUAL BEFORE ATTEMPTING TO USE THE INSTRUMENT

To comply with the standards IEC 60601-1 for safety and IEC 60601-1-2 for EMC the audiometer is designed to be used only with the medically-approved mains adapter supplied, which is specified as part of the equipment. **Do not use any other type of mains adapter with this instrument. Refer to Section 12 for the stock number of the adapter.**

The audiometer is for indoor use only and should be used only as described in this manual.

The transducers supplied with the audiometer are specifically calibrated with it; if these transducers are changed calibration will be required.

Do not immerse the unit in any fluids. See Section 8 of this manual for the proper cleaning procedure for the instrument and its accessories and the function of single-use parts.

Do not use the instrument in an oxygen-rich environment or in the presence of a flammable anaesthetic mixture or other flammable agents.

Do not drop or otherwise impact this instrument. If the instrument is dropped or damaged, return it to the manufacturer for repair and/or calibration. Do not use the instrument if any damage is suspected.

The instrument must be stored and used within the specified temperature, pressure and humidity ranges (see Sections 7 and 9).

Do not attempt to open, modify or service the instrument. Return the instrument to the manufacturer or distributor for all repair and servicing requirements. Opening the instrument will void the warranty.

2.2. ELECTROMAGNETIC COMPATIBILITY (EMC) CONSIDERATIONS

Medical electrical equipment needs special precautions regarding EMC and needs to be installed and put into service according to the EMC information provided in Appendix 1. This provides guidance on the electromagnetic environment in which to operate the instrument.

Portable and mobile radio-frequency (RF) communications equipment can affect medical electrical equipment. The instrument should not be used adjacent to or stacked with other equipment; if this is necessary the instrument should be observed to verify normal operation.

2.3. POWER SUPPLY OPTIONS

The audiometer is designed for continuous operation and may be powered either by a mains adapter (which is supplied, and specified as part of the equipment) or optional internal batteries.

Battery operation

To fit batteries (if configured for this option), remove the battery compartment cover on the base of the audiometer, fit the 4 x 1.5V 'C' batteries supplied (UK only) according to the indications on the battery holder and replace the battery cover.





Batteries should only be changed outside the patient environment. The operator should not touch the battery connectors and the patient simultaneously.

Note: If using batteries, the instrument will automatically switch off approximately 45 or 90 seconds after the last key was pressed (depending on the Battery timeout option set – see Section 3.4.2) in order to save battery power. Any test results will be automatically saved.

The display will show “Low Batt” when the battery voltage is low. It is advisable to change the batteries as soon as this happens. Once the voltage of the batteries is too low to operate the instrument the message “Replace Battery” will appear. Note that local regulations are likely to cover disposal of the batteries.

Mains operation

All other connections must be made **before** connecting the output lead from the adapter into the POWER input socket on the back of the audiometer. Switch on the mains supply - the indicator on the adapter and the POWER indicator on the audiometer will both illuminate green, showing that the instrument is ready for use.

The output from mains adapter is fitted with electronic circuit protection. In case of overload the adapter will shut down and the indicator will be extinguished. When the fault is cleared the adapter will operate as normal.

The input to the mains adapter is protected with a non-replaceable fuse. If this fails the adapter will not operate.

The mains adapter is the mains disconnect device and therefore the audiometer should be positioned such that easy access to the mains adapter is possible. If a replacement mains adapter is required, please contact Amplivox or your Amplivox distributor.

2.4. AUDIOMETER CONNECTIONS

All the relevant accessory terminals and connections are labelled to ensure correct identification and connection as follows:

Socket Label	Socket Type	Colour Code	Connected Part	Notes
RIGHT	6.3mm jack	Red	Air conduction headset *	
LEFT	6.3mm jack	Blue		
BONE	6.3mm jack	Grey	Bone Vibrator Headset *	
INSERT	3.5mm jack		Masking Earphone *	
PRINTER	RJ12 socket (6-way)		Printer *	See 2.5
USB	USB Connector Type B		Computer (via USB port)	See 2.6
N/A	6 pin mini DIN		Reserved port; Amplivox diagnostic use only	See below
POWER	2.5mm power jack		Mains AC/DC Adapter *	
RESPONSE	6.3mm jack	Black	Patient Response Switch *	

The relevant part numbers are indicated in Section 12

Note regarding the 6-pin mini DIN connector:

This is a restricted socket for Amplivox use only. No user access is permitted.





For connected parts marked * only connect the accessories supplied with the instrument or supplied by Amplivox or an Amplivox distributor. These parts have been tested for use with the Model 240 Diagnostic Audiometer for compliance with the standards IEC 60601-1 and IEC 60601-1-2. The use of accessories other than those specified may compromise compliance with these standards. For other sockets refer to Appendix 2.

2.5. DATA TRANSFER TO A PRINTER



Refer to Appendix 2 for important information regarding the connection of non-medical electrical equipment to medical electrical equipment.

The audiometer can be upgraded with an option to allow connection to one of three designated portable thermal printers for printing air and bone conduction results (see Section 3.8). The designated cable, which is supplied for each printer, must be used.

Upon receipt of the printer it must be initially charged for a minimum of 15 hours prior to use.

2.6. DATA TRANSFER TO A COMPUTER



Please Refer to Appendix 2 for important information regarding the connection of non-medical electrical equipment to medical electrical equipment.

The audiometer is supplied with software to allow connection to a computer for the transfer of test results (see Section 3.9). You must use the designated USB cable which is available from Amplivox (see Section 12).



3. USING THE AUDIOMETER

3.1. SWITCHING THE AUDIOMETER ON AND OFF

Press and briefly hold the switch marked  (located on the back panel). No warm-up time is required. The display will briefly show the model and the type of headphone currently in use.

If a secondary headphone has been enabled (e.g. E-5A) it will then be necessary to select the required headphone as follows:

- Either - press YES to confirm the current headphone selection
- Or - press NO to toggle to the other option and then YES to confirm the selection

Note: headphone selection must be confirmed before any other operation can be performed.

The display will then be similar to that shown in Section 3.3.

To switch off, press the switch marked  again, or press and hold the MENU key followed by the YES (RIGHT) key and then release both.

3.2. TESTING THE PATIENT RESPONSE SWITCH

Press the patient response switch and the light labelled RESPONSE (above and to the right of the display) will illuminate green.

3.3. AUDIOMETER DISPLAY

On start-up the display will show the following default setting:-

SIGNAL dBHL	FREQUENCY Hz	MASKING dBHL
30dB	1kHz	OFF
< >	< >	

This indicates that when the PRESENT key is pressed, a tone will be presented at 30dBHL at a frequency of 1kHz (1000Hz) to the designated ear. On start up the audiometer defaults to the left ear.

3.4. AUDIOMETER CONTROLS

3.4.1 Multifunction Keys

Several keys on the audiometer have different functions depending on the actual mode of operation. These are MENU (OFF), PULSE (RESET), LEFT (NO), RIGHT (YES), MASK (RESULTS), BONE (AUTO) and FREQUENCY $\leftarrow \rightarrow$ (MENU SELECT). The use of these keys is described below.

3.4.2 MENU

Pressing and holding MENU accesses the following options. Use the MENU SELECT keys to step through the available options and then the NO, YES or SIGNAL $\downarrow \uparrow$ keys to select an action or modify a setting. Release of the MENU key then initiates the action or saves the modified setting and returns to the default display.



<u>Menu Option</u>	<u>Description</u>
Switch off?	As described in Section 3.1
Set Auto	This enables options for automatic testing to be selected - see Section 4.5.1 for details
Clear test?	Press YES and release MENU to clear the Threshold Retention Function results from the previous test
Save audiogram to 1	Use the SIGNAL ↓↑ keys to select the required storage location and press the YES key to save the audiogram; then release MENU
Load audiogram no 1	Use the SIGNAL ↓↑ keys to select the required storage location and press the YES key to load the audiogram; then release MENU
Contrast	Adjust contrast using the SIGNAL ↓↑ keys
Battery	Shows either “Not in use” or the battery voltage, e.g. “5.3v”.
Bone masking	Use the SIGNAL ↓↑ keys to select the AC headset or the optional masking earpiece as the means of masking
Print audiogram?	Press YES and release MENU; then press YES to confirm the print operation or NO to cancel
Battery timeout	Use the SIGNAL ↓↑ keys to select either 45 or 90 seconds (see Section 2.3)
Select phones	This option is only available if the E-5A insert earphone is enabled; use the SIGNAL ↓↑ keys to select either the DD45 headphone or the E-5A insert earphone
Store on 2 of 3?	If activated a hearing threshold will be stored automatically when the patient makes a response to 2 out of 3 tone presents (see 3.5.2)
Warble to phones?	Use the NO and YES keys to send frequency-modulated tones to the headphones
Default level	Adjust the default tone presentation level using the SIGNAL ↓↑ keys
Select printer	Use the SIGNAL ↓↑ keys to select either the Able AP1300 or the Sanibel MPT-II printer

3.4.3 Description of Function of Other Keys

PULSE	This enables the pulse tone present function when the PRESENT key is operated; the indicator above the key illuminates green
RESET	Cancels an automatic test
MASK	This switches on narrow band masking (default level 30dBHL); the indicator above the key illuminates green
RESULTS	Press this key when an automatic test has been completed to displays the results; use the LEFT and RIGHT keys to display the results for the required ear and the FREQUENCY ⇐ ⇨ keys to view the entire frequency range.
+20dB	This enables tone levels to be presented with up to 20dB higher output; press the key and then use SIGNAL ↑ to access the extra 20dB; an indicator above the key illuminates green to show that the function is active, and an additional display message indicates levels greater than 100dBHL
BONE	Outputs the signal to the bone vibrator; the indicator above the key illuminates green



AUTO	Press and release this key while holding the MENU key to initiate an automatic test; to cancel the test press the RESET key
TALK OVER	Hold this key to interrupt the test and route the operator's voice from the front panel microphone to the headset; the level is adjusted with the SIGNAL ↓↑ keys; if an automatic test is in progress the current test frequency will be retested from the default level
LEFT	Press once to select the left ear; the indicator above the key illuminates green; if the left ear is already selected press again to store the displayed signal value as a threshold (see Section 3.5.1)
RIGHT	Press once to select the right ear; the indicator above the key illuminates green; if the right ear is already selected press again to store the displayed signal value as a threshold (see Section 3.5.1)
SIGNAL	Press the ↓↑ keys to decrease or increase the level of the tone presented in 5dB steps; to scroll through the range keep the key pressed
FREQUENCY	Press the ⇐ key to select a lower frequency and the ⇒ key to select a higher frequency
MASKING	With the MASK function on, press the MASKING ↓↑ keys to decrease or increase the masking level in 5dB steps; to scroll through the range keep the key pressed
PRESENT	Press to present the displayed test signal to the patient. The "PRESENT" indicator above the display will illuminate green during presentation

3.5. THRESHOLD RETENTION FUNCTION

This function records the thresholds for both ears at each frequency tested (air conduction and bone conduction). Thresholds may be stored manually or automatically.

The operator can then review the results at the end of the test and record them on an audiogram card, print them with the optional printer (see Section 3.8), save them to the internal memory (see Section 3.6) and/or transfer the results to a computer (see Section 3.9).

3.5.1 Recording thresholds manually

Once a threshold has been determined press the "selected" ear key once again. The threshold will be recorded and displayed as shown in the illustration in 3.5.3. **Note: this function will not operate if the "Store on 2 of 3" option has been enabled (see Section 3.5.2).**

3.5.2 Recording thresholds automatically

If the "Store on 2 of 3" option has been enabled (see Section 3.4.2) then a threshold will be recorded automatically by the audiometer if the patient makes a response to two out of three manual tone presentations at the same level and frequency. Thresholds determined using the "Store on 2 of 3" option are displayed within square brackets.

3.5.3 Reviewing retained thresholds

To review the retained thresholds, select the required frequency using the FREQUENCY ⇐ ⇒ keys. The recorded values for the left and right ears are shown on the lower line of the display as illustrated below.

SIGNAL dBHL	FREQUENCY Hz	MASKING dBHL	
30dB		4kHz	This display shows thresholds at 4kHz
20	10		
THRESHOLDS			Left ear 20dBHL
			Right ear 10dBHL

To clear the Threshold Retention memory, use the Clear Test menu option described in Section 3.4.2.

To record and review bone conduction thresholds use the BONE key.



3.6. SAVING AUDIOGRAMS IN INTERNAL MEMORY

The user may store up to 12 audiograms (AC & BC data), referenced by number, in the internal memory of the audiometer. To save the current set of audiogram thresholds (the “retained” values described in Section 3.5) press and hold the MENU key, press FREQUENCY ⇨ repeatedly until “Save Audiogram to 1” appears on screen. Use the SIGNAL keys ↓↑ to select a location numbered 1-12, and then press the YES key. Release the MENU key once confirmation appears on the display.

Note that the Save process will overwrite any records that exist in the selected memory location.

3.7. LOADING AUDIOGRAMS FROM INTERNAL MEMORY

Press and hold the MENU key, press FREQUENCY ⇨ repeatedly until “Load Audiogram no 1” appears on screen. Use the SIGNAL keys ↓↑ to select a location numbered 1-12, and then press the YES key. Release the MENU key once confirmation appears on the display.

3.8. PRINTING AUDIOGRAMS

Three designated thermal printers (the Able AP1300 or the Sanibel MPT-II) are available as options for use with the Model 240 audiometer. The correct printer must be selected (use the MENU options described in Section 3.4.2 to make this selection).

- Connect the PRINTER socket on the audiometer (6-way RJ12) to the printer with the supplied cable (refer to Section 2.5 of this operating manual for printer set-up). **Note that the printer cables for the Able printer (A108) and the Sanibel MPT-II (A102) are not compatible.**
- Ensure the printer is fully charged, switched on, loaded with paper and ready to print.
- Load the desired audiogram as described in Section 3.7; to print the current audiogram ignore this instruction.
- Press and hold the MENU key and press the FREQUENCY ⇨ key to display “Print Audiogram”. Continue to hold the MENU key, press the YES key and release the MENU key. On the prompt “Is printer ready?” press the YES key again. The audiogram will then print. To cancel the print operation press NO.

3.9. DATA TRANSFER TO NOAH OR AMPLISUITE

To transfer test results stored within the audiometer to a NOAH database the Amplivox NOAH Audilink software must be installed on to a computer. Alternatively, Amplivox ampliSuite allows data to be transferred to a computer and subsequently viewed, annotated & printed. This software is supplied on a CD which includes this operating manual.

Refer to the installation & operating instructions provided with NOAH Audilink or ampliSuite for further details.



4. SUGGESTED SEQUENCE OF OPERATION AND TEST PROCEDURE

The following applies to air conduction measurements. Refer also to ISO 8253 for guidance.

4.1. AUDIOMETRY PREPARATION AND AMBIENT CONDITIONS

Refer to the appropriate audiometric standards and other relevant publications for guidance on audiometric testing.

Audiometric testing should always be performed in quiet conditions (e.g. a quiet room or an acoustic booth). The optional Audiocups can provide an additional level of isolation from ambient noise. For further explanation on permissible ambient noise levels, please refer to the audiometry standard ISO6189.

4.2. TEST SYSTEM ARRANGEMENT

The schematic diagram below shows a typical example of the use of audiometric test equipment. The audiometer is located on the desk of a seated operator as shown.

The patient is seated in front of the desk facing away from the operator. The patient wears a headset or appropriate transducer (see Section 4.3) and responds to test stimuli by use of a hand-held switch which is also connected to the instrument.

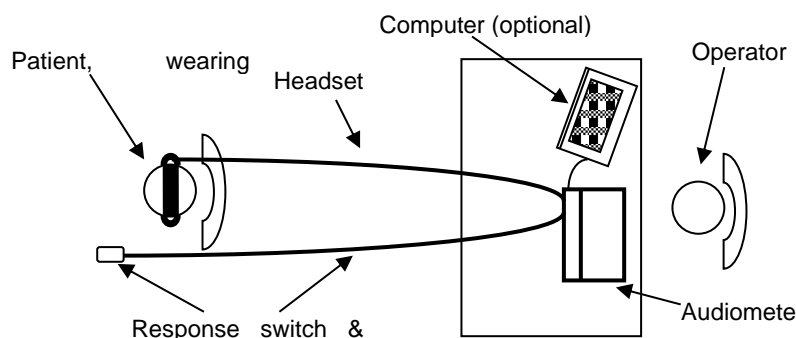

4.3. HEADSET

The headset or appropriate transducer must be fitted by a qualified person to ensure a proper seal and a comfortable fit. The leads from the headset are connected to the instrument and the headset is then fitted to the patient.

4.4. MANUAL AUDIOMETRY

4.4.1 Pre-test

- (1) Switch the audiometer on
- (2) Perform a listening check
- (3) Decide whether to use the manual or automatic Threshold Retention Function and/or an audiogram card to record the thresholds
- (4) If the automatic Threshold Retention Function is required ensure that the Store on 2 of 3 option is enabled (see Section 3.5.2) and that a patient response switch is in use
- (5) Prepare the test environment & patient (see Sections 4.1 to 4.3)
- (6) If the patient response switch is in use give instructions to the patient to acknowledge any tone presented as follows:
"As soon as you hear the tone, press the switch. When you no longer hear the tone release the switch".
- (7) Select the better hearing ear (according to the patient) by pressing either the LEFT or RIGHT key



4.4.2 Post-test

- (1) Present the tone 30dB at 1kHz for between 1 and 2 seconds. If there is no response at 30dB, increase the attenuation level in 10dB steps until the patient responds
- (2) When the patient responds, wait for 1 to 2 seconds and present the tone again at the same level; however, if the patient does respond at 30dB, reduce the signal level in 10dB steps, repeating the presentation until there is no response, then increase the signal level in 5dB steps until the patient responds; wait 1 to 2 seconds and present the tone again at the same level
- (3) If the responses are consistent with the pattern of tone presentation proceed to Section 4.4.3 and start measuring the patient's hearing thresholds; if not, repeat the familiarisation process

4.4.3 Post-test

- (1) Present the first test tone at 30dB at 1kHz
- (2) If the patient responds, reduce the signal level in 10dB steps repeating the presentation until there is no response; then increase the signal level in 5dB steps until the patient responds
- (3) If the patient does not respond, increase the signal level in 5dB steps until there is a response and then continue with step 4.
- (4) Repeat the test by reducing the signal level in 10dB steps until the patient no longer responds. Then increase the signal level in 5dB steps until the patient responds and note this level.
- (5) Repeat step 4 until the patient responds three out of a maximum of five times at the same signal level. This indicates the patient's hearing threshold level for that frequency. Either mark the threshold on an audiogram card or press the appropriate ear key once to activate the Threshold Retention Function and save the threshold level on screen.
- (6) Proceed to the next test frequency. It is common practice to test the frequencies in the following order: 1k, 2k, 3k, 4k, 6k, 8k and 500 Hz.
- (7) Repeat steps 1 to 6 for the other ear.

4.4.4 Post-test

- (1) Use the Threshold Retention Function to review the results (See 3.5)
- (2) If required do one or more of the following:
 - Record the results on an audiogram card, or
 - Save the results to the internal memory (Section 3.6), or
 - Print the results (Section 3.8), or
 - Transfer the results to a computer (Section 3.9)

Refer to Section 3.4.2 to clear the thresholds at the end of a test and, if required, switch off the audiometer.

4.5. AUTOMATIC AUDIOMETRY

4.5.1 Pre-test

- (1) Switch the audiometer on
- (2) Perform a listening check
- (3) Use "Set Auto" from MENU (see Section 3.4.2) to adjust the automatic test settings. While holding down the MENU key use the MASKING ↓ ↑ keys to step through the available options and the SIGNAL ↓ ↑ keys to change the settings as required:
 - 250 - select Y or N to include or exclude a test at 250Hz
 - 1K5 - select Y or N to include or exclude a test at 1.5kHz
 - 8K - select Y or N to include or exclude a test at 8kHz
 - FAM - select Y or N to include or exclude include a familiarization sequence to allow the patient to become familiar with the tones and establish an initial threshold at 1kHz
 - Set Auto - select 2of3 (which records a threshold when the patient has made 2 correct responses from 3 test tones) or 3of5 (which records a threshold when the patient has made 3 correct responses from 5 test tones)
- (4) Prepare the test environment & patient (see Sections 4.1 to 4.3)



- (5) Give the following instructions to the patient.
“As soon as you hear the tone, press and release the response switch.

4.5.2 Familiarisation

If the familiarization option has been selected (Section 4.5.1 – step 3) an automatic test will commence with a trial run at 1kHz starting from -10dB to allow the patient to become familiar with the increasing level and operating the response switch.

If the automatic familiarisation run is not used (or if the patient is having difficulty responding to the presented tones) the familiarisation process described in Section 4.4.2 may be used.

4.5.3 Test

- (1) To test both ears ensure that the left ear is selected
- (2) To test the right ear only ensure that the right ear is selected; to test the left ear only cancel the test once the right ear testing has begun
- (3) To initiate a test press and hold the MENU key, then press the AUTO key and release both

The automatic test will then proceed, starting with the familiarising routine (if selected) and then testing at 1kHz followed by the higher frequencies before testing for lower frequencies. The test may be cancelled at any time by pressing the RESET key; any thresholds established will be retained unless cleared or overwritten.

Automatic testing proceeds by increasing the tone level in 5dB steps until a response is made, then decreasing the level by 10dB and presenting another tone. If there is no response the level is increased in 5dB steps, and when a response is made the level is attenuated again by 10dB.

When 3 responses are made to 5 tone presentations at the same level (“3of5”), this is taken to be the threshold. The “2of3” option records a threshold if 2 responses are made to 3 tone presentations.

If an error occurs, for example the patient does not respond to the loudest tone presented or holds down the response button continuously then the test will pause with a message displayed. The operator will have the option to repeat the test at the same frequency (press the YES key) or to skip to the next frequency (press the NO key).

The TALKOVER key may be used to interrupt the test and give further instructions to the patient (see Section 3.4.3).

An automatic test concludes with a re-test at 1kHz to ensure that consistent responses have been made. If the threshold levels are not consistent the operator is given the option to repeat or skip the re-test.

4.5.4 Post-test

When an automatic test has concluded, pressing the RESULTS key will display the thresholds that were established. Use the FREQUENCY $\leftarrow \rightarrow$ keys to view all the frequencies. One or more of the following actions may then be taken:

- record the thresholds manually on an audiogram card
- print the results by pressing the RESET key
- return to the default display by pressing the LEFT key

The thresholds are retained by the audiometer and may be viewed, stored, printed or transferred to a computer (see Section 4.4.4).

Refer to Section 3.4.2 to clear the thresholds at the end of a test and, if required, switch off the audiometer.



4.5.5 Error messages

The following error messages are possible while an automatic test is running. Depending on circumstances it may be necessary to provide further instruction to the patient and/or perform manual familiarisation (see Section 4.4.2).

No response!

This occurs when the patient has made no response and the tone level has reached the maximum value. An option to repeat the test at that frequency is presented. Press YES to repeat or NO to skip to the next frequency. If the frequency is skipped the message "Test finished incomplete" will be displayed at the conclusion of the test.

Response always!

This indicates that the patient has not released the response switch and the tone level has reached the minimum value. An option to repeat the test at that frequency is presented. Press YES to repeat or NO to skip to the next frequency. If the frequency is skipped the message "Test finished incomplete" will be displayed at the conclusion of the test.

1KHz match exceeded!

This occurs when the threshold level found at the 1kHz re-test differs by more than 10dB from that found for the 1st test (see Section 4.5.3). An option to repeat the re-test is presented. Press YES to repeat or NO to accept the threshold level found at the re-test.

Test finished incomplete

This occurs if the audiometer was unable to record a threshold at one or more frequencies (e.g. if no response was made and the retry option was not chosen). The operator then has the option to use manual audiometry to obtain any missing thresholds. Press RESULTS to continue.



5. SPECIFICATION

5.1. OUTPUT DATA

Outputs: Left earphone, Right earphone, Bone (L&R) and Insert masking
Frequency range (Hz): Air: 125-8kHz
Bone: 250Hz-8kHz
Frequency accuracy: <1%
Distortion: <2%
Output level range (AC): -10dBHL min; see Section 5.2 for maximum
Output level range (BC): -10dBHL min; see Section 5.2 for maximum
Insert masking output: 90dBHL max (250-4KHz)
Output level accuracy: Within 3dB
Output level step size: 5dB
Output transducer (AC): DD45 earphones; insert earphones E-5A
Tone present: Single, warble or pulsed
Masking: Narrowband
Communication: Integral talk over facility
USB interface: Transfer of test results to a computer

5.2. MAXIMUM HEARING LEVELS PROVIDED AT EACH FREQUENCY

Frequency, Hz	Air conduction, dBHL (DD45)	Bone conduction, dBHL (B-71)
125	80	-
250	100	45
500	115	60
750	120	65
1000	120	70
1500	120	70
2000	120	70
3000	120	70
4000	115	70
6000	110	50
8000	100	40

5.3. PHYSICAL DATA

Display: 2 lines of 24 characters
Battery power (optional): 4x1.5V "C" cells (alkaline recommended)
Mains Power: 100-240Vac; 50-60Hz; 0.5A
Input Rating: 5Vdc; 1.2 A
Dimensions: 270mm long x 165mm deep x 60mm high
Weight: 0.75kg (approx)
Safety: IEC 60601-1 (plus UL, CSA & EN deviations)
EMC: IEC 60601-1-2
CE mark: To the EU Medical Device Directive



5.4. EQUIPMENT CLASSIFICATION

Type of protection against electric shock	Powered via SELV ClassII mains adapter
Degree of protection against electric shock	Type B applied part
Degree of protection against ingress of water	Not protected
Mode of operation	Continuous operation
Equipment mobility	Portable

The Model 240 Audiometer is classified as a Class IIa device under Annex IX of the EU Medical Devices Directive. It is intended for use as a diagnostic audiometer instrument.



6. SYMBOLS

The following symbols appear on the audiometer or mains adapter:



Definition: Identifies the control by means of which the instrument is switched on from (or returned to) a standby condition.



Definition: Refer to instruction manual (mandatory).



Definition: Type B applied part – an applied part providing protection against electric shock, particularly regarding allowable patient leakage current and patient auxiliary current.

The applied parts are the left & right earphones, bone vibrator, insert masker, patient response switch and the associated cables.

DC

Definition: The output from the mains AC adapter is Direct Current.

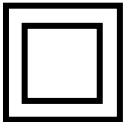

Definition: Class II equipment – equipment in which protection against electric shock does not rely on basic insulation only, but in which additional safety precautions such as double insulation or reinforced insulation are provided, there being no provision for protective earthing or reliance upon installation conditions.



7. TECHNICAL INFORMATION

Audiometer

Audiometer type: Type 3 (IEC 60645-1:2001)
Type 3 (ANSI S3.6:2004)

Battery function

Battery voltage range: 4.0 to 6.0V.
Low battery warning: approx 4.4V.
Expected battery life: 6 to 8 hours use from alkaline batteries.

Frequency Modulation

Carrier frequencies: 125Hz to 8kHz as per pure tones
Modulation waveform: Sinusoidal
Rising and falling symmetry: Symmetrical on linear frequency scale
Modulating frequency: 15.625Hz
Frequency deviation: +/-10%

Masking Sounds

Masking sounds available: Narrow band at test frequencies
Narrow-band noise bandwidth: Meets IEC 60645-1; ANSI S3.6
Reference levels: Refer to ISO 389-4

Insert Masking Earpiece

Calibration method: With 2cc coupler compliant with IEC 126

Transducers

Types and reference levels: DD45: ISO 389-1, Table 2
E-5A: ISO 389-2, Table 1
B-71: ISO 389-3, Table 1
Static headband force: Headphones: 4.5N
Bone vibrator: 5.4N
Bone vibrator calibrated: For mastoid placement & unoccluded test ear
Sound attenuation characteristics: ISO8253-1, Table 3
Airborne sound from bone vibrator: See Br. J. Audiol. 1980, P73-75
Earphone Sound Attenuation Characteristics

Frequency, Hz	125	250	500	1000	2000	4000	8000
Attenuation, dB	2	5	7	15	25	31	23

Environmental

Operating temperature: +15°C to +35°C
Operating humidity: 30% to 90% (non-condensing)
Atmospheric pressure: 700 hPa to 1060 hPa

Input / Output

Power input: 2.5mm barrel-type socket.
Patient response input: 6.3mm Jack socket
Left / Right / Bone outputs: 6.3mm Jack socket
Insert output: Mono 3.5mm Jack socket
USB: Type B socket
Printer: RJ12 socket (6-way)
Maximum voltage at any output: 12V peak



8. ROUTINE MAINTENANCE

8.1. AUDIOMETER MAINTENANCE

The Model 240 audiometer is a precision instrument. Handle it carefully in order to ensure its continued accuracy and service. When cleaning the instrument, first disconnect it from the mains supply. Use a soft cloth and mild detergent to clean the instrument panel when required. Refer to ISO 8253-1 for additional guidance.

8.2. TRANSDUCER MAINTENANCE

Before use check the transducer cables and connectors for signs of wear and/or damage. If you find any, please replace the item immediately by contacting Amplivox or your Amplivox distributor, requesting the relevant part number (see Section 12).

Handle the audiometric headset, bone vibrator headset and other accessories with care. For parts that are in direct contact with the patient it is recommended that replacement parts are used or the parts are subjected to a standard disinfecting procedure between patients.

This includes physically cleaning and use of a recognised disinfectant. The specific manufacturer's instructions should be followed for use of this disinfecting agent to provide an appropriate level of cleanliness.



During the cleaning process do not allow moisture to enter the earphone, insert masker or microphone grills etc. For specific accessories refer to the sections below.

8.3. EARPHONES

Clean the ear cushions (including those on the Audiocups, if used) with a recognised disinfectant, e.g. a "Mediswab".

8.4. INSERT EARPHONE/MASKER

Never insert or in any way use the insert masker without using a new, clean and fault-free test tip. This part is for single use only - that is, each test tip is intended to be used once only for a single ear for a single patient. Do not reuse test tips as this will pose the risk of ear-to-ear or patient-to-patient cross-infection.

8.5. INSERT EARPHONES

The disposable foam eartips supplied with the optional EarTone5A insert transducers are for single use only - that is, each eartip is intended to be used once only for a single ear for a single patient. Do not reuse eartips as this will pose the risk of ear-to-ear or patient-to-patient cross infection.

Further guidance is provided below:

- ◆ Ensure that the black tubing protruding the foam eartip is **not** applied to the patient; this must be attached to the sound tube of the insert transducer
- ◆ Roll the foam eartip into the smallest possible diameter
- ◆ Insert the eartip into the ear canal of the patient
- ◆ Hold the eartip until it has expanded and a seal is achieved
- ◆ After testing the patient the foam eartip including the black tubing must be detached from the sound tube
- ◆ The insert transducer should be examined prior to attaching a new foam eartip



8.6. MAINS ADAPTER MAINTENANCE

Before use check the mains AC adapter for signs of wear and/or damage. If you find any replace the adapter immediately by contacting Amplivox or your Amplivox distributor. Refer to Section 12 for approved part numbers.



DO NOT USE ANY OTHER TYPE OF MAINS ADAPTER WITH THIS INSTRUMENT. See Section 2.3.



9. INSTRUMENT STORAGE AND TRANSPORTATION

This instrument can be stored or transported within the following environmental parameters:

Temperature: -20°C to +70°C
Humidity: 10% to 90% (non-condensing)
Atmospheric Pressure: 500 hPa to 1060 hPa

Batteries (if fitted) should be removed if the instrument is not to be used over an extended period of time.

10. CALIBRATION AND REPAIR OF THE INSTRUMENT

Amplivox recommends that this audiometer should be calibrated on an annual basis. Please contact Amplivox or the designated distributor for details of calibration services. Refer to ISO 8253-1 for additional guidance.



The instrument should be returned to the manufacturer for service & repair. There are no user-serviceable parts within it.

When packing the instrument for shipping, please use the original shipping carton and packing materials. Please also ensure that the headset leads are not wrapped around the headband of the headset.



11. GUARANTEE

All Amplivox instruments are guaranteed against faulty materials and manufacture. The instrument will be repaired free of charge for a period of three years from the date of despatch if returned, carriage paid, to the Amplivox service department. Return carriage is free of charge for customers in the UK and chargeable for overseas customers.

Important Note:

The following exceptions apply:

Earphones, bone vibrator and other transducers may go out of calibration due to rough handling or impact (dropping). The life of the leads is also dependent upon conditions of use. These parts are only guaranteed against faulty materials or manufacture.



12. ORDERING CONSUMABLES AND ACCESSORIES

To order consumables, additional accessories and to replace detachable parts that have been damaged, please contact Amplivox for current prices and delivery charges. The items available are listed below:

Stock No.		Description
A022	8010855	Audiocups (noise reducing earphone enclosures)
AC1042	8010835	Audiocup ear cushion
AC1047	8507381	Audiocup headband
AC1048	8010834	Audiocup headband cover
A023	8010840	Headband (standard headphone)
A026	8010857	Earphone cushion
A032	8010876	Earphones DD45 *
A030	8010822	Headset lead
A080	8506731	Bone vibrator B71 *
A025	8011098	Bone vibrator headband
A029	8011136	Bone vibrator lead
B128	8004674	Carrying case
	8512734	Approved mains adapter (UE12LCP)
A085	8103838	Patient response switch
A051	8013007	Audiogram cards (pack of 50)
C15	8507921	Masking earpiece *
C13	8001127	Masking earpiece ear tip
C12	8507175	Masking earpiece ear hanger
C14	8004447	Masking earpiece lead
A200	8010797	Insert earphones *
PT02	8029305	Printer Sanibel MPT-II
A102	8004419	Printer cable for audiometer to Sanibel MPT-II
C0104	8029305	Thermal Printer paper for Sanibel MPT-II
F07	8507230	USB Cable, 2.0m



Accessories marked * require calibration with the specific audiometer to be used. Do not attempt to use these accessories until the audiometer has been calibrated to match their characteristics.

Shipping documentation will reference the stock number quoted above, and images of the parts alongside the relevant stock number are available on the Amplivox website (www.amplivox.ltd.uk). The required fitting instructions are supplied with each part.



13. DISPOSAL INFORMATION



Amplivox Limited is fully compliant with the WEEE (Waste Electrical and Electronic Equipment) Regulations. Our PRN (Producer Registration Number) is WEE/GA0116XU and we are registered with the approved WEEE Compliance Scheme, B2B Compliance, approval number WEE/MP3338PT/SCH.

The main purpose of the WEEE Regulations is to encourage the segregation of waste electrical items from the general waste stream and into reuse, recovery and recycling routes. For any waste electrical units purchased from Amplivox that either:

- bear the crossed out wheeled bin symbol with black bar underneath
- or, have been replaced with new Amplivox products on a like-for-like basis

please contact our WEEE Compliance Scheme using the details below. B2B Compliance will be able to provide further information on how to recycle your waste electrical units and answer any queries you may have.

B2B Compliance

Tel: +44 (0) 1691 676 124 (Option 2)

Email: operations@b2bcompliance.org.uk



APPENDIX 1 - EMC GUIDANCE & MANUFACTURER'S DECLARATION

Guidance and manufacturer's declaration – electromagnetic emissions		
The Model 240 Audiometer is intended for use in the electromagnetic environment specified below. The customer or user of Model 240 Audiometer should assure that it is used in such an environment.		
Emissions test	Compliance	Electromagnetic environment – guidance
RF emissions CISPR 11	Group 1	The Model 240 Audiometer uses RF energy only for its internal function. Therefore, its RF emissions are very low and are not likely to cause interference in nearby electronic equipment.
RF emissions CISPR 11	Class B	The Model 240 Audiometer is suitable for use in all establishments, including domestic establishments and those directly connected to the public low-voltage power supply network that supplies buildings used for domestic purposes.
Harmonic emissions IEC 61000-3-2	Class A	
Voltage fluctuations/flicker emissions IEC 61000-3-3	Complies	

Guidance and manufacturer's declaration – electromagnetic immunity (1)			
The Model 240 Audiometer is intended for use in the electromagnetic environment specified below. The customer or user of the Model 240 Audiometer should assure that it is used in such an environment.			
Immunity test	IEC 60601 test level	Compliance level	Electromagnetic environment – guidance
Electrostatic Discharge (ESD) IEC 61000-4-2	±8 kV contact ±15 kV air	±8 kV contact ±15 kV air	Floors should be wood, concrete or ceramic tile. If floors are covered with synthetic material, the relative humidity should be at least 30%
Electrical fast transient/burst IEC 61000-4-4	±2 kV for power supply lines ±1 kV for input/output lines	±2 kV for power supply lines ±1 kV for input/output lines	Mains power quality should be that of a typical commercial or hospital environment
Surge IEC 61000-4-5	±1 kV differential mode ±2 kV common mode	±1 kV differential mode ±2 kV common mode	Mains power quality should be that of a typical commercial or hospital environment



Immunity test	IEC 60601 test level	Compliance level	Electromagnetic environment – guidance
Voltage dips, short interruptions and voltage variations on power supply input lines (100V/60Hz & 240V/50Hz) IEC 61000-4-11	0% UT (100% dip in UT) for 0.5 cycle 0% UT (100% dip in UT) for 1 cycle 40% U _T (60% dip in U _T) for 5 cycles 70% UT (30% dip in UT) for 500ms 0% UT (100% dip in UT) for 5 sec	0% UT 100% dip in UT) for 0.5 cycle 0% UT (100% dip in UT) for 1 cycle 40% U _T (60% dip in U _T) for 5 cycles 70% UT (30% dip in UT) for 500ms 0% UT (100% dip in UT) for 5 sec	Mains power quality should be that of a typical commercial or hospital environment. If the user of the Model 240 Audiometer requires continued operation during power mains interruptions, it is recommended that the Model 240 Audiometer be powered from an uninterruptible power supply or a battery
Power frequency (50/60 Hz) magnetic field IEC 61000-4-8	30 A/m	30 A/m	Power frequency magnetic fields should be at levels characteristic of a typical location in a typical commercial or hospital environment.
NOTE U _T is the a.c. mains voltage prior to the application of the test level			

Guidance and manufacturer's declaration – electromagnetic immunity (2)			
The Model 240 Audiometer is intended for use in the electromagnetic environment specified below. The customer or user of the Model 240 Audiometer should assure that it is used in such an environment.			
Immunity test	IEC 60601 test level	Compliance level	Electromagnetic environment – guidance
Conducted RF IEC 61000-4-6	10 Vrms 150kHz to 80MHz	10 Vrms 150kHz to 80MHz	Portable and mobile RF communications equipment should be used no closer to any part of the Model 240 Audiometer, including cables, than the recommended separation distance calculated from the equation applicable to the frequency of the transmitter. Recommended separation distance $d = 1.2\sqrt{P}$ $d = 1.2\sqrt{P}$ 80MHz to 800MHz $d = 2.3\sqrt{P}$ 800MHz to 2.5GHz



Guidance and manufacturer's declaration – electromagnetic immunity (2)

<p>Radiated RF IEC 61000-4-3</p>	<p>10 V/m 80MHz to 2.7GHz</p>	<p>10 V/m 80MHz to 2.7GHz</p>	<p>where P is the maximum output power rating of the transmitter in Watts (W) according to the transmitter manufacturer and d is the recommended separation distance in metres (m).</p> <p>Field strengths from fixed RF transmitters, as determined by an electromagnetic site survey, ^a should be less than the compliance level in each frequency range. ^b</p> <p>Interference may occur in the vicinity of equipment marked with the following symbol:</p> 
--------------------------------------	-----------------------------------	-----------------------------------	---

NOTE 1 At 80MHz and 800MHz, the higher frequency range applies.

NOTE 2 These guidelines may not apply in all situations. Electromagnetic propagation is affected by absorption and reflection from structures, objects and people.

- a Field strengths from fixed transmitters, such as base stations for radio (cellular/cordless) telephones and land mobile radios, amateur radio, AM and FM radio broadcast and TV broadcast cannot be predicted theoretically with accuracy. To assess the electromagnetic environment due to fixed RF transmitters, an electromagnetic site survey should be considered. If the measured field strength in the location in which the Model 240 Audiometer is used exceeds the applicable RF compliance level above, the Model 240 Audiometer should be observed to verify normal operation. If abnormal performance is observed, additional measures may be necessary, such as re-orienting or relocating the Model 240 Audiometer.
- b Over the frequency range 150 kHz to 80 MHz, field strengths should be less than 3 V/m.



Recommended separation distances between portable and mobile RF communications equipment and the Model 240 Audiometer

The Model 240 Audiometer is intended for use in an electromagnetic environment in which radiated RF disturbances are controlled. The customer or the user of the Model 240 Audiometer can help prevent electromagnetic interference by maintaining a minimum distance between portable and mobile RF communications equipment (transmitters) and the Model 240 Audiometer as recommended below, according to the maximum output power of the communications equipment.

Rated maximum output power of transmitter W	Separation distance according to frequency of transmitter		
	m		
	150 kHz to 80 MHz $d = 1.2\sqrt{P}$	80 MHz to 800 MHz $d = 1.2\sqrt{P}$	800 MHz to 2.5 GHz $d = 2.3\sqrt{P}$
0.01	0.12	0.12	0.23
0.1	0.38	0.38	0.73
1	1.2	1.2	2.3
10	3.8	3.8	7.3
100	12	12	23

For transmitters rated at a maximum output power not listed above, the recommended separation distance d in metres (m) can be estimated using the equation applicable to the frequency of the transmitter, where P is the maximum output power rating of the transmitter in Watts (W) according to the transmitter manufacturer.

NOTE 1 At 80MHz and 800MHz, the separation distance for the higher frequency range applies.

NOTE 2 These guidelines may not apply in all situations. Electromagnetic propagation is affected by absorption and reflection from structures, objects and people.

NOTE 3 WARNING: Portable RF communications equipment (including peripherals such as antenna cables and external antennas) should be used no closer than 30cm (12 inches) to any part of the Model 240 audiometer including cables specified by the manufacturer. Otherwise degradation of the performance of this equipment could result.



APPENDIX 2 - USE WITH NON-MEDICAL ELECTRICAL EQUIPMENT

Any person who connects external equipment to signal input, signal output or other connectors has created a medical electrical system and is therefore responsible for the system complying with the requirements of clause 16 of IEC 60601-1:2005 (*General requirements for basic safety and essential performance*).

If connections are made to standard equipment such as printers and computers, special precautions must be taken in order to maintain medical safety. The following notes are provided for guidance in making such connections to ensure that the general requirements of clause 16 of IEC 60601-1:2005 are met.

The following signal inputs and outputs on the Model 240 audiometer are electrically isolated to the requirements of IEC 60601-1 in order to reduce any potential hazard associated with the use of mains-powered equipment connected to these inputs and outputs:

Socket Label	Socket Type	Typical Connection
PRINTER	RJ12 socket (6-way)	Printer
USB	USB Connector Type B	Computer

External equipment intended for connection to signal input, signal output or other connectors, shall comply with the relevant IEC or international standards (e.g. IEC 60950, CISPR 22 & CISPR 24 for IT equipment, and the IEC 60601 series for medical electrical equipment).

Equipment not complying with IEC 60601 shall be kept outside the patient environment, as defined in IEC 60601-1:2005 (at least 1.5m from the patient).

The operator must not touch the connected equipment and the patient at the same time as this would result in an unacceptable hazard.

Refer to Diagrams 1 to 3 below for typical configurations of connected peripheral equipment. Refer to Amplivox Limited at the address given on the front of this user manual if advice is required regarding the use of peripheral equipment.



Diagram 1: Model 240 used with the medically-approved mains adapter

Mains Outlet



Medical Mains Adapter



Model 240
Audiometer



Diagram 2: Model 240 used with the medically-approved mains adapter and printer

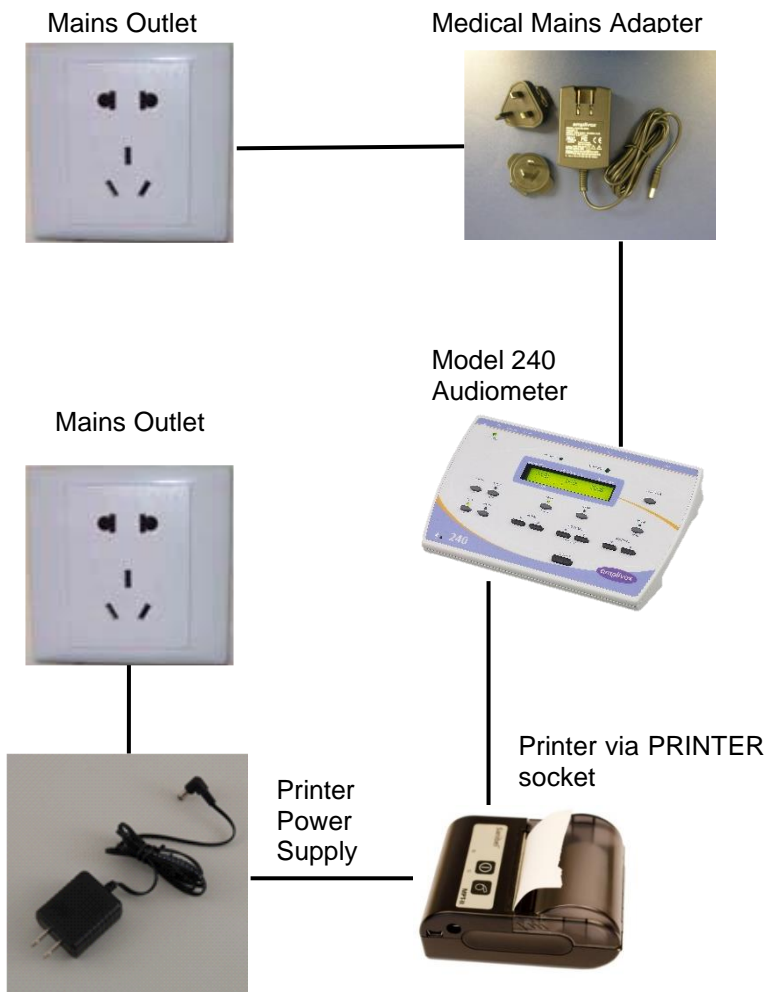
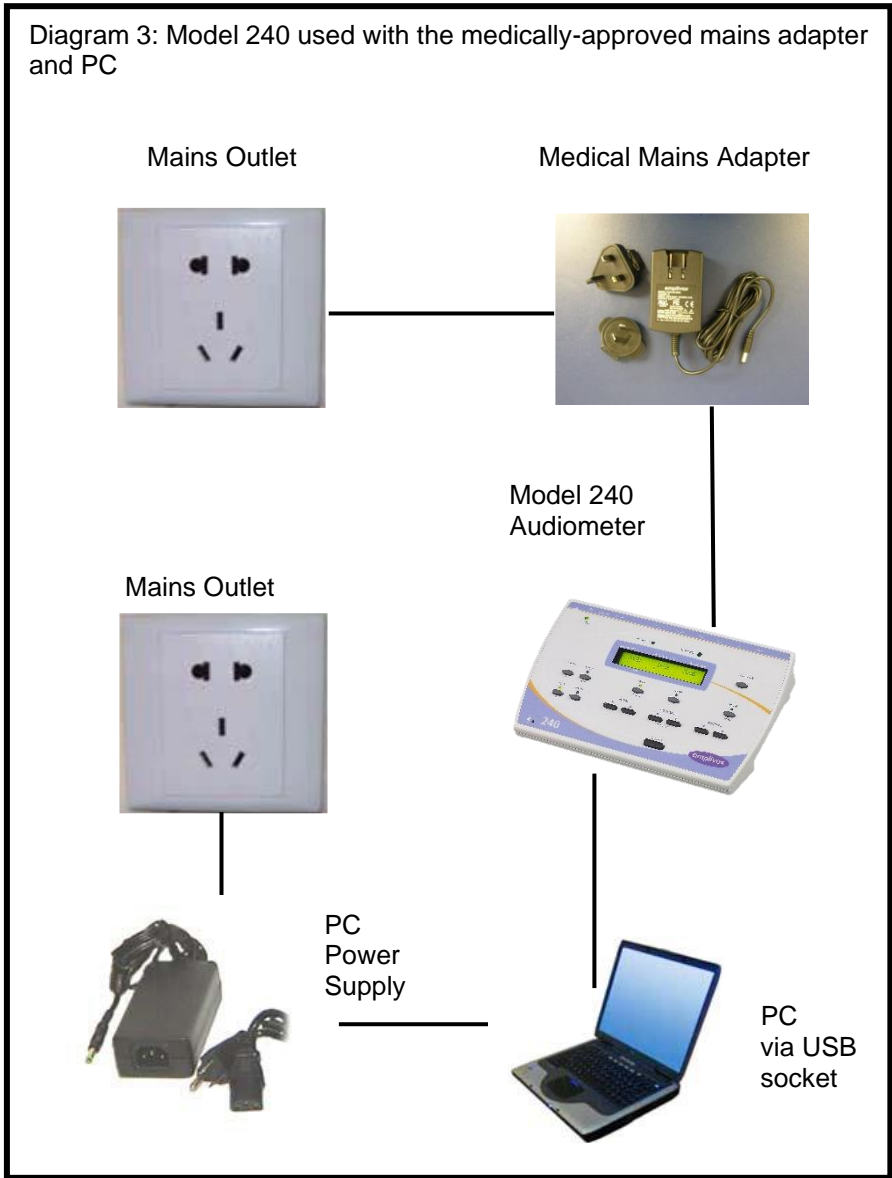

Diagram 3: Model 240 used with the medically-approved mains adapter and PC



All rights reserved. No part of this publication may be reproduced or transmitted in any form or by any means without the prior written permission of Amplivox Ltd.

Copyright © 2020 Amplivox Ltd.

