



Model 270

Operating Manual



ABOUT THIS MANUAL

READ THIS OPERATING MANUAL BEFORE ATTEMPTING TO USE THE INSTRUMENT.

This manual is valid for the Model 270 (applies from firmware version 2T06 onwards – please refer to section 1.3).

Amplivox Ltd.
6 Oasis Park, Eynsham
Oxfordshire, OX29 4TP
United Kingdom
www.amplivox.ltd.uk

This product is manufactured by:

Amplivox Ltd.
10393 West 70th Street
Eden Prairie
MN 55344
www.amplivox.us

Tel: +44 (0)1865 880846
Fax: +44 (0)1865 880426
sales@amplivox.ltd.uk

For all enquiries please contact us under:

Tel: 888 941 4208
Fax: 952 903 4100
info@amplivox.us

CE 0088

For supply in US only

Caution: Federal Law restricts this device to sale by or on the order of a licenced medical professional.

CONTENTS

1.	INTRODUCTION	1
1.1.	INTENDED APPLICATIONS	1
1.2.	UNPACKING.....	1
1.3.	FIRMWARE VERSION.....	1
1.4.	STANDARD CONTENTS.....	1
1.5.	OPTIONAL ACCESSORIES.....	1
2.	IMPORTANT SAFETY INSTRUCTIONS.....	2
2.1.	PRECAUTIONS.....	2
2.2.	ELECTROMAGNETIC COMPATIBILITY (EMC) CONSIDERATIONS.....	2
2.3.	MAINS SUPPLY OPERATION	2
2.4.	AUDIOMETER CONNECTIONS	3
2.5.	DATA TRANSFER TO A PRINTER	3
2.6.	DATA TRANSFER TO A COMPUTER	4
2.7.	LINE IN/OUT CONNECTION (AUDIO).....	4
3.	USING THE AUDIOMETER	5
3.1.	SWITCHING THE AUDIOMETER ON AND OFF.....	5
3.2.	OPERATING LANGUAGE	5
3.3.	TESTING THE PATIENT RESPONSE SWITCH	5
3.4.	AUDIOMETER DISPLAY	5
3.5.	AUDIOMETER CONTROLS.....	5
3.6.	THRESHOLD RETENTION FUNCTION	8
3.7.	SAVING AUDIOGRAMS IN INTERNAL MEMORY	8
3.8.	LOADING AUDIOGRAMS FROM INTERNAL MEMORY	8
3.9.	PRINTING AUDIOGRAMS.....	9
3.10.	DATA TRANSFER TO NOAH OR AUDIVIEW.....	9
4.	SUGGESTED SEQUENCE OF OPERATION AND TEST PROCEDURE	10
4.1.	AUDIOMETRY PREPARATION AND AMBIENT CONDITIONS	10
4.2.	TEST SYSTEM ARRANGEMENT	10
4.3.	HEADSET	10
4.4.	PATIENT INSTRUCTIONS.....	10
4.5.	PRE-TEST	10
4.6.	TEST.....	11
4.7.	POST-TEST	11
5.	SPECIFICATION	12
5.1.	OUTPUT DATA.....	12
5.2.	MAXIMUM HEARING LEVELS PROVIDED AT EACH FREQUENCY	12
5.3.	PHYSICAL DATA	12
5.4.	EQUIPMENT CLASSIFICATION	12
6.	SYMBOLS.....	14
7.	TECHNICAL INFORMATION	15
8.	ROUTINE MAINTENANCE	16
8.1.	AUDIOMETER MAINTENANCE.....	16
8.2.	TRANSDUCER MAINTENANCE.....	16
8.3.	MAINS ADAPTER MAINTENANCE.....	16
9.	INSTRUMENT STORAGE AND TRANSPORTATION	17
10.	CALIBRATION AND REPAIR OF THE INSTRUMENT	17
11.	GUARANTEE	17
12.	ORDERING CONSUMABLES AND ACCESSORIES	18
13.	DISPOSAL INFORMATION	19
APPENDIX 1 - SPEECH AUDIOMETRY		20
APPENDIX 2 - FREE FIELD CALIBRATION PROCEDURE.....		23
APPENDIX 3 - EMC GUIDANCE & MANUFACTURER'S DECLARATION.....		27

1. INTRODUCTION

Thank you for purchasing an Amplivox audiometer. The Amplivox Model 270 is a diagnostic audiometer that will give many years of reliable service if treated with care.

1.1. INTENDED APPLICATIONS

The Model 270 diagnostic audiometer is designed for use by audiologists, general practitioners, hearing aid dispensers and child health professionals. Capable of undertaking both air and bone conduction tests with or without masking, the audiometer has many additional features such as the facility to support speech audiometry from live or recorded sources, the option to select free-field equivalent output from the headphones in speech mode and a range of clinical audiometry tests.

1.2. UNPACKING

Open the shipping carton and carefully remove all the equipment. Check against the delivery note that all the accessories ordered have been included with your audiometer. If anything is missing, please contact Amplivox Customer Support (+44 1865 880846; sales@amplivox.ltd.uk). If you have purchased from a distributor you should contact them directly.

Please retain the shipping carton and packing materials as the audiometer will need calibrating on an annual basis and should be returned to Amplivox in its original shipping carton.

1.3. FIRMWARE VERSION

This operating manual is for firmware versions 2T06 onwards. To check the version of firmware on your audiometer press the OPTIONS button followed by the TALKOVER button.

1.4. STANDARD CONTENTS

STANDARD COMPONENTS

Model 270 Audiometer		Audiometric headset	
Bone vibrator headset		Patient response switch	
Mains adaptor		Audiogram cards	
Operating manual & AudiView		NOAH Audilink software	
Carrying case		Calibration certificate	

1.5. OPTIONAL ACCESSORIES

OPTIONAL COMPONENTS

Masking earpiece		Additional audiogram cards	
Microphone and monitor headset		Insert earphones	
Printer(s)		Printer cable(s)	
USB Cable		Audiocups (noise reducing earphone enclosures)	



2. IMPORTANT SAFETY INSTRUCTIONS



The Model 270 instrument must be used only by practitioners qualified to perform audiometric tests. It is intended for use as a screening and diagnostic tool.

2.1. PRECAUTIONS

READ THIS OPERATING MANUAL BEFORE ATTEMPTING TO USE THE INSTRUMENT

To comply with the standards IEC 60601-1 for safety and IEC 60601-1-2 for EMC the audiometer is designed to be used only with the medically-approved mains adapter supplied, which is specified as part of the equipment. Do not use any other type of mains adapter with this instrument. Refer to Section 12 for the stock number of the adapter.

The audiometer is for indoor use only and should be used only as described in this manual.

The transducers supplied with the audiometer are specifically calibrated with it; if these transducers are changed calibration will be required.

Do not immerse the unit in any fluids. See Section 8 of this manual for the proper cleaning procedure for the instrument and its accessories and the function of single-use parts.

Do not use the instrument in an oxygen-rich environment or in the presence of a flammable anaesthetic mixture or other flammable agents.

Do not drop or otherwise impact this instrument. If the instrument is dropped or damaged, return it to the manufacturer for repair and/or calibration. Do not use the instrument if any damage is suspected.

The instrument must be stored and used within the specified temperature, pressure and humidity ranges (see Sections 7 and 9).

Do not attempt to open, modify or service the instrument. Return the instrument to the manufacturer or distributor for all repair and servicing requirements. Opening the instrument will void the warranty.

2.2. ELECTROMAGNETIC COMPATIBILITY (EMC) CONSIDERATIONS

Medical electrical equipment needs special precautions regarding EMC and needs to be installed and put into service according to the EMC information in Appendix 3. This provides guidance on the electromagnetic environment in which to operate the instrument.

Portable and mobile radio-frequency (RF) communications equipment can affect medical electrical equipment. The instrument should not be used adjacent to or stacked with other equipment; if this is necessary the instrument should be observed to verify normal operation.

2.3. MAINS SUPPLY OPERATION

The audiometer is designed for continuous operation and is powered by a mains adapter which is supplied, and specified as part of the equipment. If a replacement is required, please contact your Amplivox distributor.

All other connections must be made **before** connecting the output lead from the adapter into the POWER input socket on the back of the audiometer. Switch on the mains supply - the indicator on the adapter and the POWER indicator on the audiometer will both illuminate green, showing that the instrument is ready for use.

The output from mains adapter is fitted with electronic circuit protection. In case of overload the adapter will shut down and the indicator will be extinguished. When the fault is cleared the adapter will operate as normal.



The input to the mains adapter is protected with a non-replaceable fuse. If this fails the adapter will not operate.

The mains adapter is the mains disconnect device and therefore the audiometer should be positioned such that easy access to the mains adapter is possible.

2.4. AUDIOMETER CONNECTIONS

All the relevant accessory terminals and connections are labelled to ensure correct identification and connection as follows:-

Socket Label	Socket Type	Colour Code	Connected Part	Notes
MIC 1	3.5mm jack		Speech Input Microphone *	
MONITOR	3.5mm jack		Monitor Earphone *	
BONE	6.3mm jack	Grey	Bone Vibrator Headset *	
INSERT	3.5mm jack		Masking Earphone *	
RIGHT LEFT	6.3mm jack 6.3mm jack	Red Blue	Air conduction headset *	
MIC 2	3.5mm jack		Talkback Microphone *	
POWER	2.5mm power jack		Mains AC/DC Adapter *	
RESPONSE	6.3mm jack	Black	Patient Response Switch *	
LINE IN	3.5mm jack		CD/tape player	See 2.7
LINE OUT	3.5mm jack		External amplifier	
DATA	6 pin mini DIN		Printer *	See 2.5
USB	USB Connector		Computer (via USB port)	See 2.6

The relevant part numbers are indicated in Section 12.



For connected parts marked * only connect the accessories supplied with the instrument or supplied by Amplivox or an Amplivox distributor. These parts have been tested for use with the Model 270 Diagnostic Audiometer for compliance with the standards IEC 60601-1 and IEC 60601-1-2. The use of accessories other than those specified may compromise compliance with these standards. For other sockets refer to Appendix 4.

2.5. DATA TRANSFER TO A PRINTER



Please refer to Appendix 4 for important information regarding the connection of non-medical electrical equipment to medical electrical equipment

The audiometer can be upgraded with an option to allow connection to one of three designated portable thermal printers for printing air conduction, bone conduction, speech and ULL test results (see 3.9). You must use the designated cable for each printer, which is supplied with this option.

Upon receipt of the printer it must be initially charged for a minimum of 15 hours prior to use.



2.6. DATA TRANSFER TO A COMPUTER



Please refer to Appendix 4 for important information regarding the connection of non-medical electrical equipment to medical electrical equipment.

The audiometer is supplied with software to allow connection to a computer for the transfer of test results (see Section 3.10). You must use the designated USB cable which is available from Amplivox (see Section 12).

2.7. LINE IN/OUT CONNECTION (AUDIO)



Please refer to Appendix 4 for important information regarding the connection of non-medical electrical equipment to medical electrical equipment.

The Model 270 has audio line in/out connections for CD or tape player input (e.g. for recorded speech testing) and amplifier output.

Line out connections are switched on only when FREEFIELD is selected. The following connections apply to both LINE IN and LINE OUT.

Main Body Segment	Mid segment	End segment
Ground	Right Channel	Left Channel

For more information on live and recorded speech please see Appendix 1.



3. USING THE AUDIOMETER

3.1. SWITCHING THE AUDIOMETER ON AND OFF

Press the key marked  highlighted centre right of the front panel. No warm-up time is required. The display will briefly show the model and the type of headphone currently selected for use.

If a secondary headphone has been enabled (e.g. E-5A) it will then be necessary to select the required headphone as follows:

- Either - press the key under OK (on the display) to confirm the current headphone selection
- Or - press the key under CHANGE to toggle to the other option and then OK to confirm the selection

Note: the headphone selection must be confirmed before any other operation can be performed. The display will then be as shown in 3.4.

To switch off, press the key marked  again and then the key under YES to confirm. To cancel switch-off press the key under NO or QUIT

3.2. OPERATING LANGUAGE

To select the operating language for the audiometer (English or German) continue to hold  when switching on. An additional display will allow the selection of English (Softkey 1) or Deutsch (Softkey 3).

3.3. TESTING THE PATIENT RESPONSE SWITCH

Press the patient response switch and the light labelled RESPONSE (to the left of the display) will illuminate green.

3.4. AUDIOMETER DISPLAY

On start-up the display will show the following default setting:-

SIGNAL		MASKING
30dBHL	1kHz	OFF
< >	< >	THL

This indicates that when the PRESENT key is pressed, a tone will be presented at 30dBHL at a frequency of 1kHz (1000Hz) to the designated ear. No masking noise is output. On start up the audiometer defaults to the left ear.

3.5. AUDIOMETER CONTROLS

3.5.1 SoftKeys

Four softkeys are provided below the display that refer to an associated option shown on the display. In this operating manual these are referenced as Softkey 1 to Softkey 4 from left to right.

3.5.2 OPTIONS key

Pressing the OPTIONS key and then using the softkeys allows the operator to step through the options (use the NEXT softkey) and modify the settings as required. Pressing the softkey below QUIT exits the options menu and saves the settings.

<u>Menu Option</u>	<u>Description</u>
Clear test?:	Clears all displayed test results if the YES key is pressed; stored test results are not affected
Save audiogram to 1:	Use the UP key to select the intended storage location and press the SAVE key



- Load audiogram no. 1:** Use the UP key to select the required storage location and press the LOAD key
- Contrast:** Adjust using the UP and DOWN keys
- Bone masking:** Selects the headset or the optional insert masking earpiece as the means of masking; select 'Insert' or 'Phones' key
- Select phones:** This option is only available if a secondary headphone is enabled; use Softkeys 1 or 2 to select the required headphone type
- FF equiv speech?:** This option is only available if either DD45 or TDH39 is the selected headphone; if activated, free-field equivalent levels will output to the headphone in speech mode (see Appendix 1)
- Store on 2 of 3?:** Automatically stores a threshold if the responses made to two out of three test signals are at the same hearing level
- Set freefield levels?:** This option provides access to the freefield calibration function; refer to Appendix 2 for details
- External talkover?:** Select NO to use the internal microphone and YES to use the MIC 1 input
- Display Counter?:** Activates a percentage counter for use with speech testing (refer to Appendix 1)
- Select printer:** Use the appropriate softkey to select either the Able (AP1300) or the Martel (MCP8830) printer or the Sanibel (MPT-II) printer.
- Please note: In order to use the Sanibel printer, select ABLE printer in the settings. After confirming the ABLE printer, the 270 will connect to the Sanibel printer, too.**
- Omit 750/1k5/3k/6k?:** To exclude these frequencies from those available for testing press the YES key
- Present Time:** Select the minimum and maximum times that a stimulus can sound when the PRESENT key is pressed; either 0.5sec (min) & 10sec (max), or 1.0 sec (min) & 2.0 sec (max)
- FF Speech units:** The units displayed for freefield speech may be switched between dBHL and dB SPL

3.5.3 Description of Function of Other Keys

- SIGNAL HL** The rotary control is used to increase or decrease the signal level in the selected step size.
- MASK HL** The rotary control is used to increase or decrease the masking level in the selected step size. (The MASK key must be selected – see below)
- SINE** Selects a pure tone as the test signal; the indicator above the key illuminates green
- WARBLE** Selects a frequency modulated tone as the test signal; the indicator above the key illuminates green
- SPEECH** Selects speech mode; the indicator above the key illuminates green; refer to Appendix 1 for details (note that initially, only Softkeys 1 & 3 have a function)
- MASK** Switches on masking at 30dBHL - narrow band (for pure tones) or speech-weighted masking; the indicators above the key and to the right of the display illuminate green; for speech mode use Softkey 4 to select INT for internally generated noise or EXT (with Softkey 1 used to select LINE) to route recorded noise via the LINE IN connection
- LEFT** Press once to select the left ear; the indicator above the key illuminates green
- RIGHT** Press once to select the left ear; the indicator above the key illuminates green
- PULSE** Enables pulse tone present function; the indicator above the key illuminates green



REVERSE	Presents the signal continuously; the indicator above the key illuminates green. Pressing the PRESENT key interrupts the signal
+20dB	This enables tone levels to be presented with up to 20dB higher output; press the key and then use the SIGNAL rotary control to access the extra 20dB; a green indicator above the key is used to show that the function is active, and an additional display message indicates levels greater than 100dBHL. Note: this function will not operate if continuous tone presentation has been enabled.
LOCK	Synchronous masking function. Locks signal and mask output at a constant difference when the SIGNAL control is adjusted. An indicator above the key illuminates green when active. The MASK control adjusts masking independently.
AIR	Outputs the signal to the earphones; the indicator above the key illuminates green
BONE	Outputs the signal to the bone vibrator; the indicator above the key illuminates green
FREEFIELD	Routes signals to LINE output socket; the indicator above the key illuminates green
Hz	Press the ← key to select a lower frequency and the → key to select a higher frequency
PRESENT	Press to present the displayed test signal to the patient. The “PRESENT” indicator to the left of the display will be illuminated green during tone presentation.
TALKOVER	Interrupts test and routes operator’s voice from the internal microphone (or MIC 1 input) to headset. The attenuation level can be adjusted with the SIGNAL rotary control.
TALKBACK	While selected (as indicated by the indicator above the key) the signal from MIC2 is routed continuously to the MONITOR output. Press the key again to de-select. The talkback level may be adjusted by the SIGNAL rotary control while key is held down.
PRINT	Press to print audiogram; see Section 3.9 for further details
dB STEP	Enables the operator to set either 2.5dB or 5dB as the default step size.
PHONES	This option is only available if a secondary headphone has been enabled; this will enable the operator to select the required output transducers.
STORE	Saves the displayed combination of frequency, attenuation and ear as a threshold retention value. Please see Section 3.6 for further details.

3.5.4 TEST MENU

This key enables the selection of the following standard tests. Exit each test by pressing the TEST MENU key again.

Menu Option Description

STENG.	Stenger: Routes tone or speech to both earphones simultaneously. Use the SIGNAL rotary control to adjust the Left channel level and the MASK rotary control to adjust the right. Refer to Appendix 1 for details of the Stenger test in speech mode.
ABLB	Alternate Binaural Loudness Balance: Routes tone to each earphone alternately. Use the SIGNAL rotary control to adjust the Left channel level and the MASK rotary control to adjust the right. Pressing the PRESENT key interrupts the signal presented.
SISI	Short Increment Sensitivity Index: Presents a tone continuously at the level and frequency displayed. Pressing the PRESENT key increases the level by the increment shown on the lower line of the display. Change this increment by using the UP & DOWN softkeys. Softkey 4 switches between the initial display and a counter that logs and displays the results of the test as a percentage:



- Use Softkey 1 to record a response
- Use Softkey 2 to record no response
- Use Softkey 3 to clear the results display
- Use Softkey 4 to return to the initial SISI display

3.6. THRESHOLD RETENTION FUNCTION

This function records the thresholds for both ears at each frequency tested (air conduction, bone conduction and ULL). Once a threshold has been determined press the STORE key. Alternatively use the “Store on 2 of 3” function (see Section 3.5.2). The threshold will be recorded and displayed as shown below.

The operator can then review the results at the end of the test and record them on an audiogram card, print them with the optional printer (see Section 3.9), save them to the internal memory (see Section 3.7) and/or transfer the results to a computer (see Section 3.10).

To review the retained thresholds, select the required frequency using the ⇐ Hz ⇒ keys. The recorded values for the left and right ears are shown on the lower line of the display, designated L and R respectively.

SIGNAL		MASKING
10dBHL	4kHz	OFF
[20L]	[10R]	THL

THRESHOLDS

This display shows thresholds at 4kHz
Left ear 20dBHL
Right ear 10dBHL

To clear the Threshold Retention memory, use the Clear Test menu option described in Section 3.5.2.

Bone Conduction and Uncomfortable Loudness Levels (ULL)

To record and review bone conduction thresholds use the BONE key.

To record uncomfortable loudness levels (ULL) press Softkey 4 with Air conduction selected. The display will be similar to that shown below, and ULL thresholds are recorded and reviewed as described above.

SIGNAL		MASKING
40dBHL	1kHz	OFF
[45L]	[40R]	ULL

3.7. SAVING AUDIOGRAMS IN INTERNAL MEMORY

The user may store up to 12 audiograms, referenced by number, in the internal memory of the audiometer. To save the current set of audiogram thresholds press the OPTIONS key, press the NEXT key repeatedly until “Save Audiogram to ” appears on screen. Use the UP key to select a location numbered 1-12 and then press the SAVE key. Any results for ULL thresholds or speech testing (see Appendix 1) will also be saved.

Note that the Save process will overwrite any records that exist in the memory location. Press the QUIT key once confirmation that the thresholds have been saved appears on the screen.

3.8. LOADING AUDIOGRAMS FROM INTERNAL MEMORY

Press the OPTIONS key and then press NEXT repeatedly until “Load Audiogram no ” appears on screen. Select the required audiogram (1-12), using the UP key and then press the LOAD key. Press the QUIT key once confirmation that the thresholds have been retrieved appears on screen.



3.9. PRINTING AUDIOGRAMS

Three designated thermal printers (the Able AP1300 or the Martel MCP8830 or the Sanibel MP-II) are available as options for use with the Model 270 audiometer. The correct printer must be selected (use the MENU options described in Section 3.5.2 to make this selection).

- Connect the audiometer to the printer with supplied printer cable (refer to Section 2.5 of this operating manual for printer set-up). Insert the 6-pin mini DIN into the DATA socket on the back of the audiometer. Insert the terminal plug into the socket at the back of the printer. **Note that the printer cables for the Able printer (stock number A105) and Martel printer (stock number A104) and the Sanibel Printer (A101) are not compatible.**
- Ensure the printer is switched on and ready to print.
- Load the desired audiogram as described in 3.8; to print the current audiogram ignore this instruction
- Press the PRINT key. On the prompt "Is printer ready?" press the YES key. The audiogram will then print.

3.10. DATA TRANSFER TO NOAH OR AUDIVIEW

To transfer test results stored within the audiometer to a NOAH database the Amplivox NOAH Audilink software must be installed on to a computer. Alternatively, Amplivox AudiView allows data to be transferred to a computer and subsequently viewed, annotated & printed. This software is supplied on a CD which includes this operating manual.

Refer to the installation & operating instructions provided with NOAH Audilink or AudiView for further details.



4. SUGGESTED SEQUENCE OF OPERATION AND TEST PROCEDURE

The following applies to air conduction measurements. For illustrative purposes 5dB steps are used. Refer also to ISO 8253 for guidance.

4.1. AUDIOMETRY PREPARATION AND AMBIENT CONDITIONS

Refer to the various audiometric standards and other relevant publications for guidance on audiometric testing.

Audiometric testing should always be performed in quiet conditions (e.g. a quiet room or an acoustic booth). The optional Audiocups can provide an additional level of isolation from ambient noise. For further explanation on permissible ambient noise levels, please refer to the audiometry standard ISO6189.

4.2. TEST SYSTEM ARRANGEMENT

The schematic diagram below shows a typical example of the use of audiometric test equipment. The audiometer is located on the desk of a seated operator as shown.

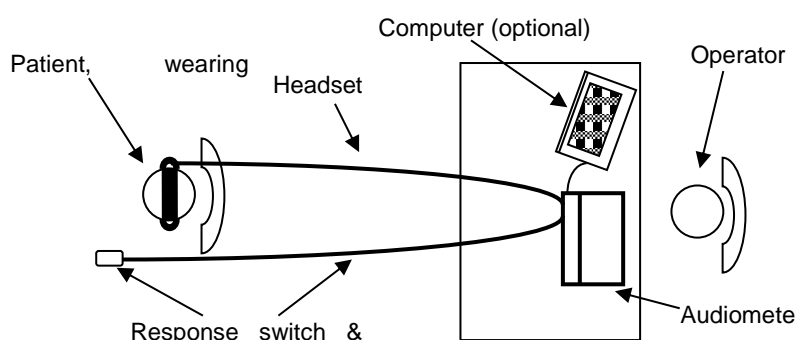

The patient is seated in front of the desk facing away from the operator. The patient wears a headset or appropriate transducer (see Section 4.3) and responds to test stimuli by use of a hand-held switch which is also connected to the instrument.

4.3. HEADSET

The headset or appropriate transducer must be fitted by a qualified person to ensure a proper seal and a comfortable fit. The leads from the headset are connected to the instrument and the headset is then fitted to the patient.

4.4. PATIENT INSTRUCTIONS

The patient should be given the following instructions using the TALKOVER function:

- “As soon as you hear the tone, press the response switch. When you no longer hear the tone release the response switch”

4.5. PRE-TEST

- (1) Connect the required accessories and switch the audiometer on
- (2) Perform a listening check
- (3) Decide whether to use the Threshold Retention Function (see Section 3.6) or an audiogram card to record the thresholds
- (4) Prepare the test environment & patient (see Sections 4.1 to 4.4)
- (5) Select the better hearing ear (according to the patient) by pressing either the LEFT or RIGHT key



4.6. TEST

- (6) Present the first test tone at 30dB at 1kHz
- (7) If the patient responds, reduce the signal level in 10dB steps until they no longer respond; then increase the signal level in 5dB steps until the patient responds
- (8) If the patient fails to hear the first tone, increase the signal level in 5dB steps until they do respond and then continue with step 9
- (9) Repeat the test by reducing the signal level in 10dB steps until the patient no longer responds; then increase the signal level in 5dB steps until they do respond and note this level
- (10) If Store on 2 of 3 is selected, go to step 12
- (11) Repeat step 9 until the patient responds three out of a maximum of five times at the same signal level, indicating the patient's hearing threshold level for that frequency; mark the threshold on an audiogram card or press the STORE key once to activate the Threshold Retention Function which displays the threshold on screen
- (12) If Store on 2 of 3 is selected, repeat step 9 until the patient has responded 2 out of a maximum of 3 times at the same signal level; this will automatically display the threshold on the screen
- (13) Proceed to the next test frequency and repeat steps 6 to 12
- (14) Repeat steps 6 to 13 for the other ear

4.7. POST-TEST

- (15) Use the Threshold Retention Function to review the results (See 3.6)
- (16) If required do one or more of the following:

- Record the results on an audiogram card, or
- Save the results to the internal memory (Section 3.7), or
- Print the results (Section 3.9), or
- Transfer the results to a computer (Section 3.10)

To clear the Threshold Retention memory, use the Clear test menu option described in Section 3.5.2.



5. SPECIFICATION

5.1. OUTPUT DATA

Outputs: Left earphone, Right earphone, Bone (L&R) Insert masking and Freefield
Frequency range (Hz): Air: 125-8kHz
Bone: 250Hz-8kHz
Frequency accuracy: <1%
Distortion: <2%
Output level range (AC): -10dBHL to 120dBHL maximum
Output level range (BC): -10dBHL to 70dBHL maximum
Output level range (FF): Up to 90dB
Insert masking output: 90dBHL max (250-4kHz)
Output level accuracy: Within 3dB
Output level step size: 2.5 or 5dB
Output transducer (AC): DD45 earphones (supplied)
E-5A insert earphones (option)
Output transducer (BC): B-71 bone vibrator (supplied)
Tone present: Single, pulsed, warble or continuous
Masking: **Narrowband (tone) or speech-weighted**
Synchronous channel: See Section 3.5.3 (LOCK)
Clinical tests: SISI, Stenger & ABLB (Fowler)
Communication: Integral talkover and talkback facility
Recorded speech: Tape or CD input
Live speech: 1 x microphone input
Monitoring indicator: VU - (to IEC 60268-17; ANSI S3.6:2004)
USB interface: Transfer of test results to a computer

5.2. MAXIMUM HEARING LEVELS PROVIDED AT EACH FREQUENCY

Frequency, Hz	Air conduction, dBHL	Bone conduction, dBHL
125	80	-
250	100	45
500	115	60
750	120	65
1000	120	70
1500	120	70
2000	120	70
3000	120	70
4000	115	70
6000	110	50
8000	100	40

5.3. PHYSICAL DATA

Display: 2 lines of 24 characters
Mains power: 100-240Vac; 50/60Hz; 0.4A
Dimensions: 355mm long x 230mm deep x 100mm high
Weight: 1.6kg
Safety: IEC 60601-1 (plus UL, CSA & EN deviations)
EMC: IEC 60601-1-2
CE mark: To the EU Medical Device Directive

5.4. EQUIPMENT CLASSIFICATION

Type of protection against electric shock Powered via SELV ClassII mains adapter
Degree of protection against electric shock Type B applied part
Degree of protection against ingress of water Not protected
Mode of operation Continuous operation



Equipment mobility

Portable

The Model 270 Audiometer is classified as a Class IIa device under Annex IX of the EU Medical Devices Directive. It is intended for use as a diagnostic audiometer instrument.



6. SYMBOLS

The following symbols appear on the audiometer or mains adapter:



Definition: Refer to instruction manual (mandatory).



Definition: Type B applied part – an applied part providing protection against electric shock, particularly regarding allowable patient leakage current and patient auxiliary current.

The applied parts are the left & right earphones, bone vibrator, insert masker, patient response switch and the associated cables.

DC 

Definition: The output from the mains AC adapter is Direct Current

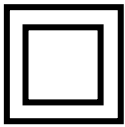

Definition: Class II equipment – equipment in which protection against electric shock does not rely on basic insulation only, but in which additional safety precautions such as double insulation or reinforced insulation are provided, there being no provision for protective earthing or reliance upon installation conditions.

7. TECHNICAL INFORMATION

Audiometer

Audiometer type: Type 2 (IEC 60645-1:2001)
 Type B-E (IEC 60645-2:1993)
 Type 3BE (ANSI S3.6:2004)

Frequency Modulation

Carrier frequencies: 125Hz to 8kHz as per pure tones
 Modulation waveform: Sinusoidal
 Rising and falling symmetry: Symmetrical on linear frequency scale
 Modulating frequency: 15.625Hz
 Frequency deviation: +/-10%

Speech Channel

Frequency response: +/- 3dB from 100Hz to 10kHz electrical
 Voltage requirement at 0dB
 input level setting to zero meter: 1.20Vrms at 1kHz
 Output level: 90dB SPL at 1kHz for attenuator setting of 70dB HL with level meter at 0dB

Masking Sounds

Masking sounds available: Narrow bands at test frequencies and Speech weighted noise
 Narrow-band noise bandwidth: Meets IEC 60645-1; ANSI S3.6
 Speech noise bandwidth: Meets IEC 60645-2; ANSI S3.6
 Reference levels: Refer to ISO 389-4

Insert Masking Earpiece

Calibration method: With 2cc coupler compliant with IEC 126

Transducers

Types and reference levels: DD45: ISO 389-1, Table 2
 E-5A: ISO 389-2, Table 1
 B-71: ISO 389-3, Table 1
 Static headband force: Headphones: 4.5N
 Bone vibrator: 5.4N
 Bone vibrator calibrated: For mastoid placement & unoccluded test ear
 Sound attenuation characteristics: ISO8253-1, Table 3
 Airborne sound from bone vibrator: See Br. J. Audiol. 1980, P73-75

Earphone Sound Attenuation Characteristics

Frequency, Hz	125	250	500	1000	2000	4000	8000
Attenuation, dB	2	5	7	15	25	31	23

Environmental

Operating temperature: +15°C to +35°C
 Operating humidity: 30% to 90% (non-condensing)
 Atmospheric pressure: 700 hPa to 1060 hPa

Input / Output

Power input: 2.5mm barrel-type socket.
 Mic input impedance: 2500 Ohms
 Mic input connection: Mono 3.5mm Jack socket
 Line input impedance: 6800 Ohms
 Line in/out connections: Stereo 3.5mm Jack Sockets
 Patient response input: 6.3mm Jack socket
 Left / Right / Bone outputs: 6.3mm Jack socket
 Monitor output: Mono 3.5mm Jack socket
 Insert output: Mono 3.5mm Jack socket
 USB: Type B socket
 Maximum voltage at any output: 12V peak



8. ROUTINE MAINTENANCE

8.1. AUDIOMETER MAINTENANCE

The Model 270 audiometer is a precision instrument. Handle it carefully in order to ensure its continued accuracy and service. When cleaning the instrument, first disconnect it from the mains supply. Use a soft cloth and mild detergent to clean the instrument panel when required. Refer to ISO 8253-1 for additional guidance.

8.2. TRANSDUCER MAINTENANCE

Before use check the transducer cables and connectors for signs of wear and/or damage. If you find any, please replace the item immediately by contacting Amplivox or your Amplivox distributor, requesting the relevant part number (see Section 12).

Handle the audiometric headset, bone vibrator headset and other accessories with care. For parts that are in direct contact with the patient it is recommended that replacement parts are used or the parts are subjected to a standard disinfecting procedure between patients.

This includes physically cleaning and use of a recognised disinfectant. The specific manufacturer's instructions should be followed for use of this disinfecting agent to provide an appropriated level of cleanliness.



During the cleaning process do not allow moisture to enter the earphone, insert masker, monitor or microphone grills etc. For specific accessories refer to the sections below.

Earphones

Clean the ear cushions (including those on the Audiocups, if used) with a recognised disinfectant, e.g. a "Mediswab".

Insert Masker

Never insert or in any way use the insert masker without using a new, clean and fault-free test tip. This part is for single use only - that is, each test tip is intended to be used once only for a single ear for a single patient. Do not reuse test tips as this will pose the risk of ear-to-ear or patient-to-patient cross infection.

Insert Earphones

The disposable foam eartips supplied with the optional EarTone5A insert transducers are for single use only - that is, each eartip is intended to be used once only for a single ear for a single patient. Do not reuse eartips as this will pose the risk of ear-to-ear or patient-to-patient cross infection.

- ◆ Ensure that the black tubing protruding the foam eartip is **not** applied to the patient; this must be attached to the sound tube of the insert transducer
- ◆ Roll the foam eartip into the smallest possible diameter
- ◆ Insert the eartip into the ear canal of the patient
- ◆ Hold the eartip until it has expanded and a seal is achieved
- ◆ After testing the patient the foam eartip including the black tubing must be detached from the sound tube
- ◆ The insert transducer should be examined prior to attaching a new foam eartip

8.3. MAINS ADAPTER MAINTENANCE

Before use check the mains AC adapter for signs of wear and/or damage. If you find any replace the adapter immediately by contacting Amplivox or your Amplivox distributor. Refer to Section 12 for approved part numbers



DO NOT USE ANY OTHER TYPE OF MAINS ADAPTER WITH THIS INSTRUMENT. See Section 2.3.



9. INSTRUMENT STORAGE AND TRANSPORTATION

Please note that this instrument can be stored or transported with the following environmental parameters:

Temperature: -20°C to +70°C
Humidity: 10% to 90% (non-condensing)
Atmospheric Pressure: 500 hPa to 1060 hPa

10. CALIBRATION AND REPAIR OF THE INSTRUMENT

Amplivox recommend that this audiometer should be calibrated on an annual basis. Please contact Amplivox or the designated distributor for details of calibration services. Refer to ISO 8253-1 for additional guidance.



The instrument should be returned to the manufacturer for service & repair. There are no user-serviceable parts within it.

When packing the instrument for shipping, please use the original shipping carton and packing materials. Please also ensure that the headset leads are not wrapped around the headband of the headset.

11. GUARANTEE

All Amplivox instruments are guaranteed against faulty materials and manufacture. The instrument will be repaired free of charge for a period of two years from the date of despatch if returned, carriage paid, to the Amplivox service department. Return carriage is free of charge for customers in the UK and chargeable for overseas customers.

Important Note:

The following exceptions apply:

Earphones, bone vibrator and other transducers may go out of calibration due to rough handling or impact (dropping). The life of the leads is also dependent upon conditions of use. These parts are only guaranteed against faulty materials or manufacture.



12. ORDERING CONSUMABLES AND ACCESSORIES

To order consumables, additional accessories and to replace detachable parts that have been damaged, please contact Amplivox for current prices and delivery charges. The items available are listed below:

Stock No.	Description
A022	Audiocups (noise reducing earphone enclosures)
AC1042	Audiocup ear cushion
AC1047	Audiocup headband
AC1048	Audiocup headband cover
A023	Headband (standard headphone)
A026	Earphone cushion
A032	Earphones DD45 *
A030	Headset lead
A080	Bone vibrator B71 *
A025	Bone vibrator headband
A029	Bone vibrator lead
C15	Masking earpiece *
C13	Masking earpiece ear tip
C12	Masking earpiece ear hanger
C14	Masking earpiece lead
A200	Insert earphones *
C17	Microphone and monitor headset
B129	Carrying case
A091-7	Approved mains adapter
A085	Patient response switch
A051	Audiogram cards (pack of 50)
A091	Printer Martel MCP8830
A104	Printer cable for audiometer to Martel MCP8830
C01	Thermal Printer paper for Martel MCP8830
PT01	Printer Able AP1300
A105	Printer cable for audiometer to Able AP1300
C0103	Thermal Printer paper for Able AP1300
PT02	Printer Sanibel MPT-II
A101	Printer cable for audiometer to Sanibel MPT-II
C0104	Thermal Printer paper for Sanibel MPT-II
F07	USB Cable, 2.0m
A109	Free field cable (connects to LINE IN/LINE OUT)



Accessories marked * require calibration with the specific audiometer to be used. Do not attempt to use these accessories until the audiometer has been calibrated to match their characteristics.

Shipping documentation will reference the stock number quoted above, and images of the parts alongside the relevant stock number are available on the Amplivox website (www.amplivox.ltd.uk). The required fitting instructions are supplied with each part.



13. DISPOSAL INFORMATION



Amplivox Limited is fully compliant with the WEEE (Waste Electrical and Electronic Equipment) Regulations. Our PRN (Producer Registration Number) is WEE/GA0116XU and we are registered with the approved WEEE Compliance Scheme, B2B Compliance, approval number WEE/MP3338PT/SCH.

The main purpose of the WEEE Regulations is to encourage the segregation of waste electrical items from the general waste stream and into reuse, recovery and recycling routes.

For any waste electrical units purchased from Amplivox that either:

- bear the crossed out wheeled bin symbol with black bar underneath
- or, have been replaced with new Amplivox products on a like-for-like basis

please contact our WEEE Compliance Scheme using the details below. B2B Compliance will be able to provide further information on how to recycle your waste electrical units and answer any queries you may have.

B2B Compliance

Tel: +44 (0) 1691 676 124 (Option 2)

Email: operations@b2bcompliance.org.uk



APPENDIX 1 - SPEECH AUDIOMETRY

The Model 270 audiometer may be used in the following speech modes of operation. However users should be aware that there is a growing body of professional opinion that Live Voice speech audiometry is generally not recommended. For recorded speech audiometry, only material with a stated relationship with the calibration signal should be used. Softkey 1 switches between MIC1 (live) or LINE (recorded) inputs.

Notes regarding the use of recorded test material:

- The audiometer line input is intended for connection to audio playback devices able to output signals having the industry standard line level voltage amplitude of 0.707Vrms.
- Using other types of output (i.e. headphone sockets, laptop audio sockets) may result in a reduction of signal level.
- While some compensation for a reduced level is possible using the audiometer, it is also possible to increase the signal levels of recorded speech test material by using freely available P.C. software. Contact your distributor for details.

Headphone and Free Field Testing

Note that the line outputs from the instrument (used for free-field testing) are only active when FREEFIELD is selected.

- If headphone testing is being performed, it is recommended that any attached amplifier should be switched off
- If Free Field testing is being performed, this option must always be selected on the audiometer; this disconnects headphones, bone vibrator and masking insert outputs, and ensures that the correct calibrated output levels are achieved
- If free-field equivalent output is required from the headphones in Speech mode this option should be selected (see Section 3.5.2)

Operator Monitoring

Where an acoustic booth/room is used, a patient microphone is connected to the MIC2 input, while the operator headset/earpiece is connected to the MONITOR output. The operator listening levels may be adjusted as follows:

- The level of the speech signal is controlled by the ⇐ Hz ⇒ keys, giving 2dB steps
- The level of the patient's responses is controlled by using the SIGNAL rotary control while pressing and holding TALKBACK

Test Modes in Speech Audiometry

Initially in speech mode either ear may be selected, with the output level controlled by the SIGNAL rotary control. Pressing TEST MENU followed by Softkey 1 routes the speech to both ears (Stenger test with speech), with the left output level controlled by the SIGNAL rotary control and the right output level controlled by the MASK rotary control. Pressing TEST MENU again returns to the original speech mode.

Display Counter

The Display Counter is available only in Speech mode. Use Softkey 3 to activate the counter. For any given level of stimulus the display then shows the percentage correct alongside the total number of responses. To use the counter the operator selects 'YES' or 'NO' according to the response made by the patient. Pressing Softkey 3 clears the counter to zero. To exit from the Display Counter screen press Softkey 4. Any results will be saved and further results may be added to those already established (use Sofkey 3 to activate the counter again).

A1.1 Live Voice Speech Audiometry to Headphones

A1.1.1 Set Up:

- a) Connect a microphone to the MIC1 input on the audiometer
- b) Press SPEECH and use Softkey 1 to ensure that 'MIC' is displayed in capitals (indicating that the external microphone is selected)
- c) The microphone is initially routed to the left earphone. To select the right earphone press RIGHT
- d) The input signal is adjusted in 1dB steps by use of the MASK rotary control
- e) Input signal adjustment should be made to adjust for the operator's voice to peak at the 0dB point on the LEVEL dB bar graph; the earphone output will then be 89dB SPL for a SIGNAL setting of 70 dBHL and 1kHz puretone into an IEC 318 ear simulator
- f) The output level is controlled in 5dB steps by the SIGNAL rotary control



A1.1.2 Procedure:

The operator may now read the required word list to the subject and record the responses; the patient may respond either by (a) repeating the spoken material or (b) writing the words. If the response is spoken, the operator should press the TALKBACK key to hear this response (see operator monitoring above).

A1.2 Live Voice Speech Audiometry with Contralateral Masking

A1.2.1 Set Up - as described in A1.1.1 then:

- a) Select MASK
- b) Speech-weighted masking is now routed to the opposite earphone to that selected
- c) The MASK rotary control changes the masking level in 5dB steps
- d) If required, readjustment of the input signal level can be accessed by temporarily deselecting the MASK key - then proceed as in A1.1.1d)

A1.2.2 Procedure:

As described in A1.1.2 but adjusting the masking level as required.

A1.3 Recorded Speech Audiometry to Headphones

A1.3.1 Set Up:

- a) Connect a CD, tape player, or other sound source to the LINE IN jack socket; refer to Section 2.7 of this operating manual
- b) Press SPEECH and use Softkey 1 to ensure that 'LINE' is displayed in capitals (indicating that the line input is selected)
- c) The line input is initially routed to the left earphone. To select the right earphone press RIGHT
- d) The input signal is adjusted in 1dB steps by use of the MASK control
- e) Play the 1kHz calibration tone on the recorded material and adjust the input signal such that the LEVEL dB bar graph reads 0dB; the headphone output measured in an IEC 318 ear simulator will now be 89dB SPL for a setting of 70 dBHL
- g) The output level is controlled in 5dB steps by the SIGNAL control

A1.3.2 Procedure:

As described in A1.1.2 except that the operator plays the recorded material to the subject.

A1.4 Recorded Speech Audiometry to Headphones with Contralateral Masking

A1.4.1 Set Up - as described in A1.3.1 then:

- a) Select MASK
- b) Speech-weighted masking is now routed to the opposite earphone to that selected
- c) Select INT or EXT masking source using Softkey4 (the option selected is displayed in capitals); internal will be wideband noise and external will be the competing noise from the signal source
- d) The MASK rotary control changes the masking level in 5dB steps
- e) If required, readjustment of the input signal level can be accessed by temporarily deselecting the MASK key - then proceed as in A1.3.1d)

A1.4.2 Procedure:

As described in A1.3.2 but adjusting the masking level as required.

IMPORTANT NOTES – FREE FIELD MODES

For the following Free Field modes of operation it is essential for the Free Field calibration procedure described in Appendix 2 of this operating manual to have been performed. This aspect may also be subject to local requirements or legislation.



A1.5 Free Field Live Voice Speech Audiometry

A1.5.1 Set Up:

- a) Connect an external amplifier/speaker to the LINE OUT jack socket; refer to Section 2.7 of this operating manual
- b) Connect a microphone to the MIC1 input on the audiometer
- c) Press SPEECH & FREEFIELD and use Softkey 1 to ensure that 'MIC' is displayed in capitals (indicating that the external microphone is selected)
- d) The external microphone is now routed to the external amplifier and speaker; use LEFT and RIGHT to select the required amplifier channel
- e) Continue from Section A1.1.1d) to Section A1.1.1f) above

A1.5.2 Procedure:

As described in A1.1.2.

A1.6 Free Field Recorded Speech Audiometry

A1.6.1 Set Up:

- a) Connect an external amplifier/speaker to the LINE OUT jack socket, and a CD, tape player, or other sound source to the LINE IN jack socket; refer to Section 2.7 of this operating manual
- b) Press SPEECH & FREE FIELD and use Softkey 1 to ensure that 'LINE' is displayed in capitals (indicating that the line input is selected)
- c) The line input is now routed to the external amplifier and speaker; use LEFT and RIGHT to select the required amplifier channel
- d) Play the 1kHz calibration tone on the recorded material and follow the calibration procedure in Appendix 2
- e) The input signal is adjusted in 1dB steps by use of the MASK control
- f) Adjust the input signal such that the LEVEL dB bar graph reads 0dB

A1.6.2 Procedure:

As described in A1.3.2

A1.7 Free Field Recorded Speech Audiometry With Competing Noise (Audiometer-Generated)

A1.7.1 Set Up: - as described in A1.6.1 then:

- a) Select MASK
- b) Select internal masking source using Softkey4 (the INT option is displayed in capitals); wideband noise is routed to the competing LINE OUT channel
- c) The level of competing noise is adjusted in 5db steps using the MASK rotary control

A1.7.2 Procedure:

As described in A1.3.2 but adjusting the competing noise level as required.

A1.8 Free Field Recorded Speech Audiometry With Competing Noise (Recorded)

A1.8.1 Set Up: as described in A1.7.1 except:

- a) Select external masking source using Softkey4 (the EXT option is displayed in capitals); competing noise from the signal source is routed to the competing LINE OUT channel
- b) Use the SIGNAL control to adjust the signal channel and MASK control to adjust the noise channel

A1.8.2 Procedure:

As described in A1.3.2 but adjusting the competing noise level as required.



APPENDIX 2 - FREE FIELD CALIBRATION PROCEDURE

A2.1 Assurance of Calibration

The following is a brief description of the equipment and procedures to be used with the Model 270 audiometer as a means of performing free-field calibration.

However it must be emphasised that it is the responsibility of the equipment operator to ensure that correct free-field calibration has been achieved, and it is recommended that the standards for free-field & speech testing & calibration (e.g. ISO 8253-3 & ISO 389-7) and other appropriate reference works are consulted.

It is assumed that the room, speakers and listening position have been set up in conformance with the relevant standards and that the required calibration equipment, operating procedures and trained technical staff are available to perform this operation. Once calibrated, items should not be moved, removed, or added to the room without re-calibration.

A2.2 External Amplifier and Loudspeaker

The following external equipment is specified for use of the Model 270 audiometer in free-field modes of operation:

- Amplifier: Interacoustics AP70
- Loudspeaker: Interacoustics ALS7

A2.3 Calibration Overview

The following calibration should be performed before any free-field tests are performed, and repeated if any changes to equipment positions or settings are made, or if there are other changes to the room (e.g. furniture moved). Place the speaker(s) in the desired position(s), at least 1.5 meters from the subject's listening position. Refer to the specification for the test to be performed for correct loudspeaker and subject alignment(s).

For calibration, the measuring microphone of a sound level meter (SLM) is placed at the reference point (the point that the subject's head will be located).

The procedures outlined below cover calibration for both speech and warble tone modes of audiometry. If both modes are to be used then speech calibration **must** be carried out first. If only warble mode is to be used then only the warble part of the calibration procedure may be carried out.

However, if speech mode is required later (and a speech calibration is performed) this will invalidate any previous warble calibration which would then need to be repeated. If warble tones are to be used as a means of equalising the frequency response in the speech calibration (see Section A2.4.1.1) then this will invalidate any previous warble calibration which would then need to be repeated when warble tone testing is required.

A2.4 Free-field Speech Calibration

This is carried out in two stages:

- 1) the speech channel, which contains two elements:
 - an optional equalisation phase
 - a level-setting phase
- 2) the competing noise channel, which may be omitted if competing noise is not required

A2.4.1 Calibrating the Speech Channel

A2.4.1.1 Equalisation (Optional)

To perform equalisation, connect an external speech source to the audiometer (e.g. CD or tape player). From the default (switch-on) condition of the audiometer select SPEECH and FREEFIELD and then play the test signal from the speech recording. This should either be:

- pink noise used with a third-octave spectrum analyser and the SLM
- third-octave noise bands used with the SLM



Use the SIGNAL control to set the output to 70dBHL, and adjust the external amplifier to give a reading of 90dB SPL as measured by the SLM at the reference point.

The response should then be checked to be within the following limits (IEC 60645-2:1993 Section 10.1):

Frequency Range (Hz)	Tolerance (dB)
125 to 250	+0/-10
250 to 4000	+3/-3
4000 to 6300	+5/-5

If necessary, adjustments should be made using the amplifier controls or an additional graphic equalizer to achieve this response.

As an alternative to using an external speech source, the warble-tone calibration method and controls (see Section A2.5) may be used to achieve this response. Note that this will invalidate any previous free-field warble tone calibration, and this must be repeated when warble tone testing is required.

A2.4.1.2 Level Setting

The calibration tone from the speech recording should be played and the external amplifier volume control used to give a reading of 90dB SPL for a 70dBHL instrument setting. Once set, no further adjustment should be made to the external amplifier or graphic equalizer controls (if used for equalisation).

If more than one set of test recordings is to be used then the following procedure can be used to allow for minor differences in calibration levels:

- Set up as above for the most commonly used test recording
- Measure the actual listening point level for when playing the calibration tone of each alternative set of test recordings
- For each alternative set of test recordings produce a correction table (the difference between the actual listening point level measured and 90dB SPL)
- Apply this correction to the output level of the audiometer while conducting a test to compensate for the minor difference in calibration level

A2.4.2 Calibrating the Competing Noise Channel

Refer directly to Section A2.5.2 if a warble tone calibration is not to be carried out. If warble tones are to be calibrated (or if the warble tone calibration method is used to equalise the speech frequency response) then the competing noise channel may be calibrated after the warble procedure as the instrument will already be in the appropriate display mode for this operation.

A2.5 Free-field Warble Tones Calibration

A2.5.1 Entering Free Field Calibration Mode

- Press OPTIONS and then the NEXT key to move through the menu items and access the 'Set freefield levels' screen. Press the YES key.
- Press QUIT and you are now presented with the freefield calibration screen for Warble tones.
- The audiometer will now output at 70dBHL from the Left channel.

As reference for the calibration of warble tone sound pressure levels, the values from ISO 389-7, Table 1 are used (binaural, on-axis).

Freq [Hz]	125	250	500	750	1000	1500	2000	3000	4000	6000	8000
dB SPL	92	81	74	72	72	70.5	68.5	64	63.5	72.5	81.5



If a calibration of the speech channel has already been carried out:

Adjust the calibration level for the 1kHz, Left channel using the SIGNAL control to reach the SPL level specified above as measured by the SLM

If a calibration of the speech channel is not required:

The output of the external amplifier should be set in order to achieve the level specified above at 1000Hz (i.e. 72dB SPL) as measured by the SLM with the audiometer set to 0dB compensation. The amplifier's level control should **not** then be changed.

When 1kHz, Left channel has been calibrated:

At every other frequency the adjustment should then be made as follows to give the above values as measured by the SLM.

- Change frequency using the ⇐ Hz ⇒ keys and then adjust the calibration level for the new frequency using the SIGNAL control to reach the correct level as measured by the SLM
- Repeat the above until all frequencies have been calibrated for the Left channel
- To calibrate the Right channel (if required) press the RIGHT key (do **not** change the amplifier's volume control)
- Adjust the calibration for all of the right channel frequencies (including 1000Hz) by using the ⇐ Hz ⇒ keys and the SIGNAL control as described above
- To store the levels and leave Free-field calibration mode, press the STORE key
- If required, all calibration levels can be set to a default of zero by pressing Softkey 1 ('Zero all') while in free-field calibration mode

It is possible that, because of the characteristics of the listening room or test set-up, the calibration levels above cannot be achieved because the limit of adjustment is reached for one or more frequencies. Re-arrangement of the listening room may improve the situation, but if not, the following is a possible solution:

- Set all of the frequencies for which calibration can be achieved
- For frequencies where this is not possible, adjust each to be a multiple of 5dBs from the required level
- Produce a correction table for each frequency for which calibration could not be achieved to be applied to the output level of the audiometer while conducting a test to relate the instrument display to actual output level from the speakers.

A2.5.2 Calibrating the Competing Noise Channel

This part of the calibration procedure may be omitted if Free-field speech calibration is not required.

- Enter the Free-field calibration mode as described in A2.5.1
- Press the SPEECH key and the display will change to indicate the option to adjust the competing noise calibration level – the legend "Sp Mask" is used to indicate this
- Without changing the setting on the external amplifier use the SIGNAL control to adjust the level of the competing noise to 90dB SPL as measured by the SLM using dBA settings.
- Calibrate each channel, pressing the RIGHT and LEFT keys to switch between channels
- If necessary it is possible to switch between speech (competing noise) and warble calibration modes by pressing SPEECH and WARBLE respectively
- To store the levels and leave Free-field calibration mode, press the STORE key

A2.6 Free-field Live Speech Calibration

Note: as stated in Appendix 1 of this operating manual, users should be aware that there is a growing body of professional opinion that Live Voice speech audiometry is generally not recommended. Exceptional skill and concentration are required to achieve accurate and consistent levels.

- Connect a microphone to the MIC1 input on the audiometer
- Press SPEECH and use Softkey 1 to ensure that 'MIC' is displayed in capitals (indicating that the external microphone is selected)
- The input signal is adjusted in 1dB steps with the MASK rotary control
- Input signal adjustment should be made to adjust for the operator's voice to peak at the 0dB point on the LEVEL dB bar graph
- If recorded speech has been calibrated no further action is necessary



- If recorded speech has not been calibrated, the volume control of the amplifier should be adjusted so that the SLM reads 90dB SPL at the listening point with a 70dB HL setting on the instrument; note that this is an approximate setting only, as it is not possible to produce a true calibration signal in live speech



APPENDIX 3 - EMC GUIDANCE & MANUFACTURER'S DECLARATION

Guidance and manufacturer's declaration – electromagnetic emissions		
The Model 270 Audiometer is intended for use in the electromagnetic environment specified below. The customer or user of the Model 270 Audiometer should assure that it is used in such an environment.		
Emissions test	Compliance	Electromagnetic environment – guidance
RF emissions CISPR 11	Group 1	The Model 270 Audiometer uses RF energy only for its internal function. Therefore, its RF emissions are very low and are not likely to cause interference in nearby electronic equipment.
RF emissions CISPR 11	Class A	The Model 270 Audiometer is suitable for use in all establishments other than domestic and those directly connected to the public low-voltage power supply network that supplies buildings used for domestic purposes
Harmonic emissions IEC 61000-3-2	Class A	
Voltage fluctuations/flicker emissions IEC 61000-3-3	Complies	

Guidance and manufacturer's declaration – electromagnetic immunity (1)			
The Model 270 Audiometer is intended for use in the electromagnetic environment specified below. The customer or user of the Model 270 Audiometer should assure that it is used in such an environment.			
Immunity test	IEC 60601 test level	Compliance level	Electromagnetic environment – guidance
Electrostatic Discharge (ESD) IEC 61000-4-2	±6 kV contact ±8 kV air	±6 kV contact ±8 kV air	Floors should be wood, concrete or ceramic tile. If floors are covered with synthetic material, the relative humidity should be at least 30%
Electrical fast transient/burst IEC 61000-4-4	±2 kV for power supply lines ±1 kV for input/output lines	±2 kV for power supply lines ±1 kV for input/output lines	Mains power quality should be that of a typical commercial or hospital environment
Surge IEC 61000-4-5	±1 kV differential mode ±2 kV common mode	±1 kV differential mode ±2 kV common mode	Mains power quality should be that of a typical commercial or hospital environment



Immunity test	IEC 60601 test level	Compliance level	Electromagnetic environment – guidance
Voltage dips, short interruptions and voltage variations on power supply input lines IEC 61000-4-11	<5% U_T (>95% dip in U_T) for 0.5 cycle 40% U_T (60% dip in U_T) for 5 cycles 70% U_T (30% dip in U_T) for 25 cycles <5% U_T (>95% dip in U_T) for 5 sec	<5% U_T (>95% dip in U_T) for 0.5 cycle 40% U_T (60% dip in U_T) for 5 cycles 70% U_T (30% dip in U_T) for 25 cycles <5% U_T (>95% dip in U_T) for 5 sec	Mains power quality should be that of a typical commercial or hospital environment. If the user of the Model 270 Audiometer requires continued operation during power mains interruptions, it is recommended that the Model 270 Audiometer be powered from an uninterruptible power supply or a battery
Power frequency (50/60 Hz) magnetic field IEC 61000-4-8	3 A/m	3 A/m	Power frequency magnetic fields should be at levels characteristic of a typical location in a typical commercial or hospital environment.
NOTE U_T is the a.c. mains voltage prior to the application of the test level			



Guidance and manufacturer's declaration – electromagnetic immunity (2)			
The Model 270 Audiometer is intended for use in the electromagnetic environment specified below. The customer or user of the Model 270 Audiometer should assure that it is used in such an environment.			
Immunity test	IEC 60601 test level	Compliance level	Electromagnetic environment – guidance
<p>Conducted RF IEC 61000-4-6</p> <p>Radiated RF IEC 61000-4-3</p>	<p>3 Vrms 150kHz to 80MHz</p> <p>3 V/m 80MHz to 2.5GHz</p>	<p>3 Vrms</p> <p>3 V/m</p>	<p>Portable and mobile RF communications equipment should be used no closer to any part of the Model 270 Audiometer, including cables, than the recommended separation distance calculated from the equation applicable to the frequency of the transmitter.</p> <p>Recommended separation distance</p> $d = 1.2\sqrt{P}$ $d = 1.2\sqrt{P} \text{ 80MHz to 800MHz}$ $d = 2.3\sqrt{P} \text{ 800MHz to 2.5GHz}$ <p>where P is the maximum output power rating of the transmitter in Watts (W) according to the transmitter manufacturer and d is the recommended separation distance in metres (m).</p> <p>Field strengths from fixed RF transmitters, as determined by an electromagnetic site survey, ^a should be less than the compliance level in each frequency range. ^b</p> <p>Interference may occur in the vicinity of equipment marked with the following symbol:</p> 
NOTE 1 At 80MHz and 800MHz, the higher frequency range applies.			
NOTE 2 These guidelines may not apply in all situations. Electromagnetic propagation is affected by absorption and reflection from structures, objects and people.			



Guidance and manufacturer's declaration – electromagnetic immunity (2)

- a Field strengths from fixed transmitters, such as base stations for radio (cellular/cordless) telephones and land mobile radios, amateur radio, AM and FM radio broadcast and TV broadcast cannot be predicted theoretically with accuracy. To assess the electromagnetic environment due to fixed RF transmitters, an electromagnetic site survey should be considered. If the measured field strength in the location in which the Model 270 Audiometer is used exceeds the applicable RF compliance level above, the Model 270 Audiometer should be observed to verify normal operation. If abnormal performance is observed, additional measures may be necessary, such as re-orienting or relocating the Model 270 Audiometer.
- b Over the frequency range 150 kHz to 80 MHz, field strengths should be less than 3 V/m.

Recommended separation distances between portable and mobile RF communications equipment and the Model 270 Audiometer

The Model 270 Audiometer is intended for use in an electromagnetic environment in which radiated RF disturbances are controlled. The customer or the user of the Model 270 Audiometer can help prevent electromagnetic interference by maintaining a minimum distance between portable and mobile RF communications equipment (transmitters) and the Model 270 Audiometer as recommended below, according to the maximum output power of the communications equipment.

Rated maximum output power of transmitter W	Separation distance according to frequency of transmitter m		
	150 kHz to 80 MHz $d = 1.2\sqrt{P}$	80 MHz to 800 MHz $d = 1.2\sqrt{P}$	800 MHz to 2.5 GHz $d = 2.3\sqrt{P}$
0.01	0.12	0.12	0.23
0.1	0.38	0.38	0.73
1	1.2	1.2	2.3
10	3.8	3.8	7.3
100	12	12	23

For transmitters rated at a maximum output power not listed above, the recommended separation distance d in metres (m) can be estimated using the equation applicable to the frequency of the transmitter, where P is the maximum output power rating of the transmitter in Watts (W) according to the transmitter manufacturer.

NOTE 1 At 80MHz and 800MHz, the separation distance for the higher frequency range applies.

NOTE 2 These guidelines may not apply in all situations. Electromagnetic propagation is affected by absorption and reflection from structures, objects and people.



APPENDIX 4 - USE WITH NON-MEDICAL ELECTRICAL EQUIPMENT

Any person who connects external equipment to signal input, signal output or other connectors has created a medical electrical system and is therefore responsible for the system complying with the requirements of clause 16 of IEC 60601-1:2005 (*General requirements for basic safety and essential performance*).

If connections are made to standard equipment such as printers and computers, special precautions must be taken in order to maintain medical safety. The following notes are provided for guidance in making such connections to ensure that the general requirements of clause 16 of IEC 60601-1:2005 are met.

The following signal inputs and outputs on the Model 270 audiometer are electrically isolated to the requirements of IEC 60601-1 in order to reduce any potential hazard associated with the use of mains-powered equipment connected to these inputs and outputs:

Socket Label	Socket Type	Typical Connection
DATA	6 pin mini DIN	Printer
LINE IN	3.5mm jack	CD/Tape Player
LINE OUT	3.5mm jack	Amplifier
USB	USB Connector	Computer

External equipment intended for connection to signal input, signal output or other connectors, shall comply with the relevant IEC or international standards (e.g. IEC 60950, CISPR 22 & CISPR 24 for IT equipment, and the IEC 60601 series for medical electrical equipment).

Equipment not complying with IEC 60601 shall be kept outside the patient environment, as defined in IEC 60601-1 (at least 1.5m from the patient).

The operator must not touch the connected equipment and the patient at the same time as this would result in an unacceptable hazard.

Refer to Diagrams 1 to 5 below for typical configurations of connected peripheral equipment. Refer to Amplivox Limited at the address given on the front of this user manual if advice is required regarding the use of peripheral equipment.



Diagram 1: Model 270 used with the medically-approved mains adapter

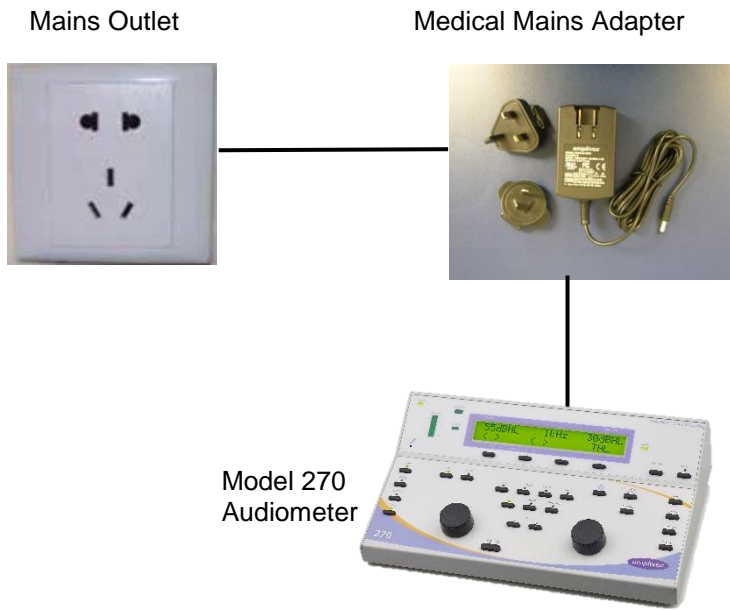

Diagram 2: Model 270 used with the medically-approved mains adapter and printer

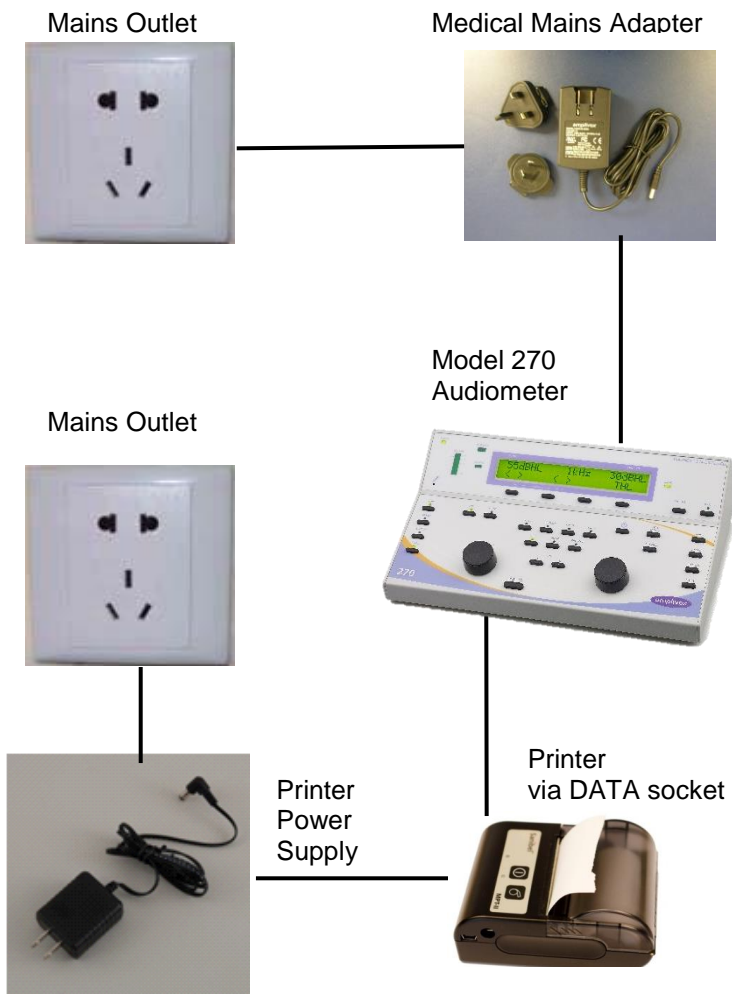

Diagram 3: Model 270 used with the medically-approved mains adapter and PC

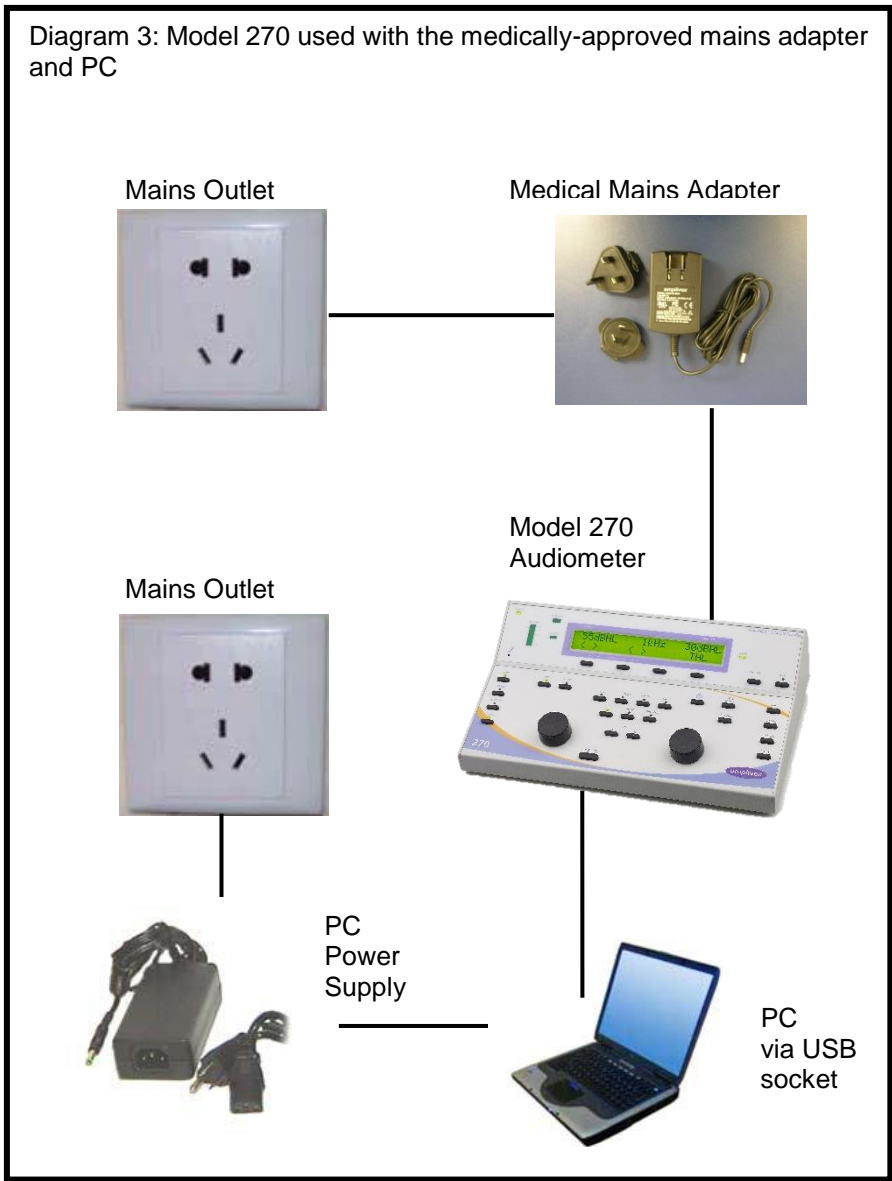

Diagram 4: Model 270 used with the medically-approved mains adapter and CD/Tape player

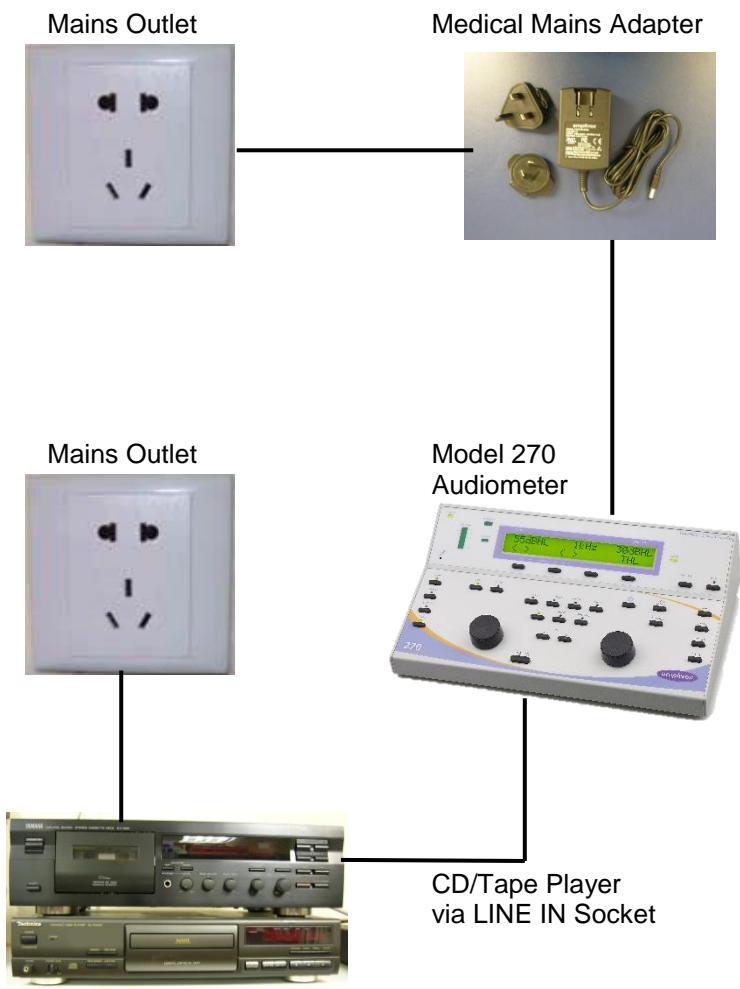

Diagram 5: Model 270 used with the medically-approved mains adapter and external amplifier

Mains Outlet



Medical Mains Adapter



Mains Outlet



Model 270
Audiometer



Amplifier
via LINE OUT
Socket



All rights reserved. No part of this publication may be reproduced or transmitted in any form or by any means without the prior written permission of Amplivox Ltd.

Copyright © 2018 Amplivox Ltd.

