

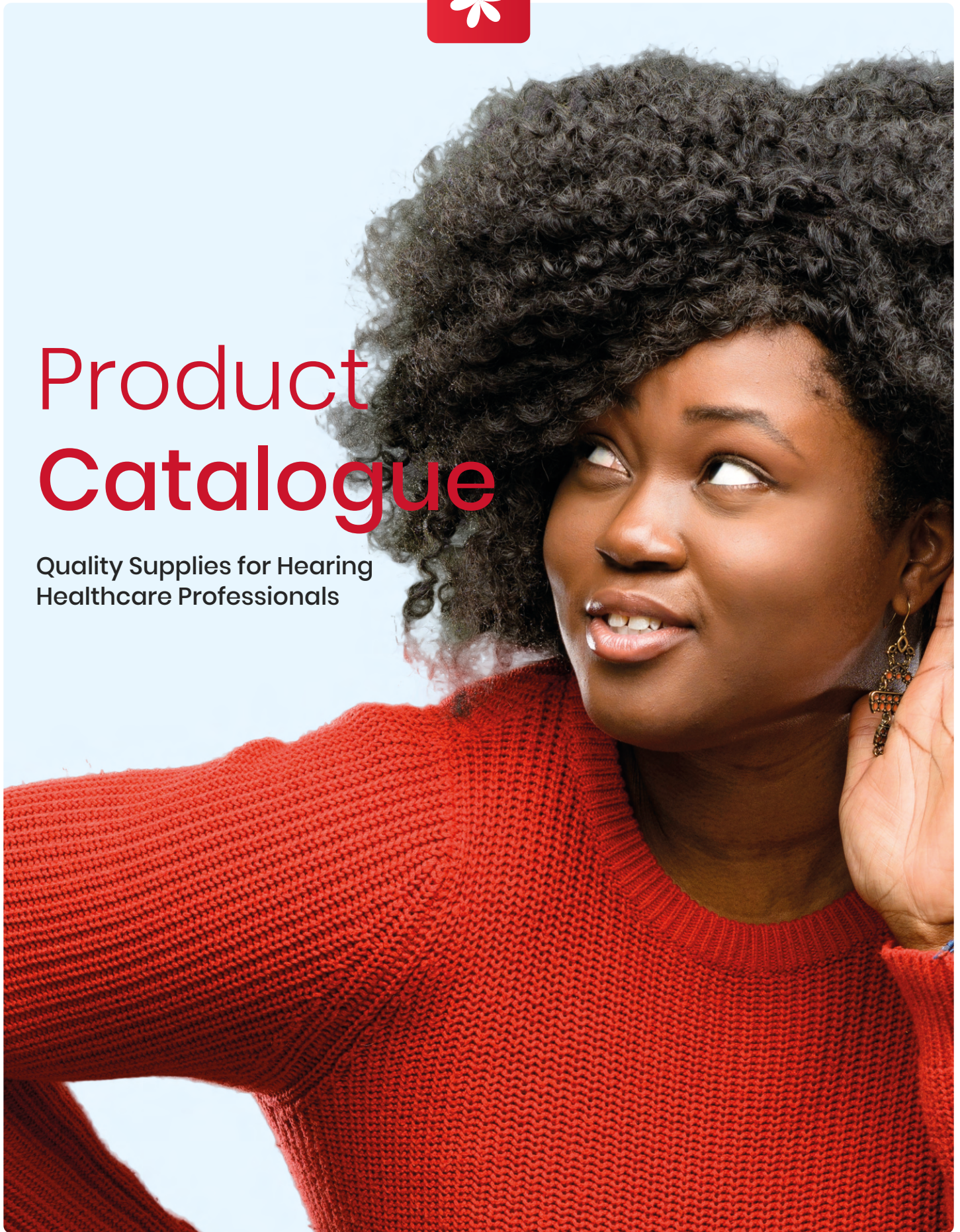

# Product Catalogue

Quality Supplies for Hearing  
Healthcare Professionals



# Contents

- 03** Disposable ear tips
- 08** Probe tips
- 10** Supplies for insert earphones
- 12** Sanibel™ Infant EarCup™ and EARturtle™
- 13** Disposable electrodes
- 16** Electrode cables
- 17** Patient preparation
- 18** Infection control
- 20** REM probe tubes for HA fitting
- 21** Impression materials and supplies
- 24** Tubing
- 25** Clinical tools
- 28** Hearing aid fitting
- 29** Hearing aid maintenance and hearing care
- 31** Cerumen Management accessories
- 33** Parts for audiometry
- 36** Balance supplies
- 37** Paper
- 38** Otoscopy Supplies
- 39** Batteries and various items

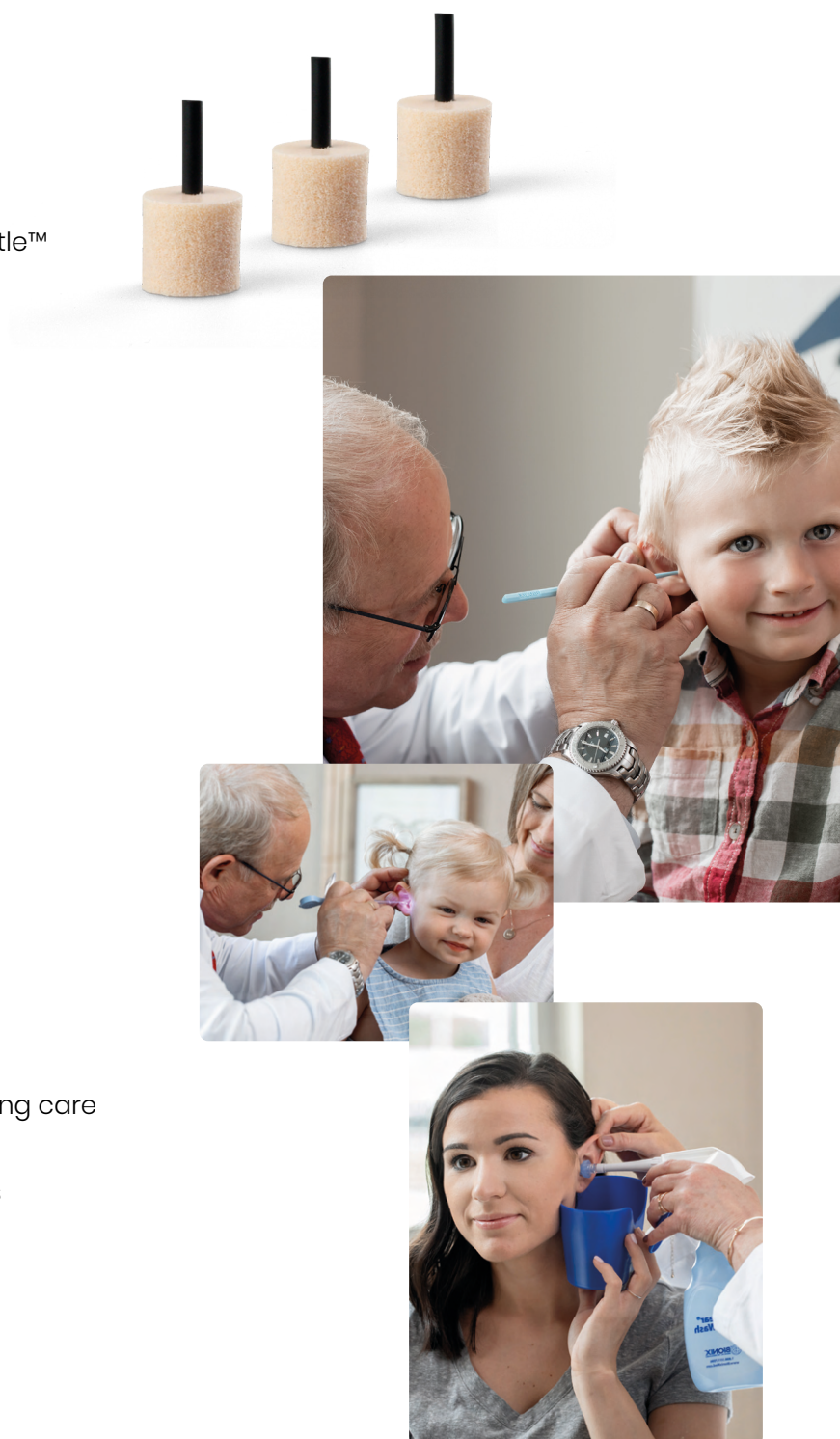

# Why use ear tips for single use only?

## Sanibel Supply® recommends using disposable ear tips for single use only to stop ear infections from spreading

At Sanibel Supply® we think that most audiologists would agree with us that it is crucial to avoid inadvertent transmission of disease within the audiology clinic. The good news is that it is quite easy to ensure that ear infections are not spread from one patient to another; use a new ear tip for each patient, and you will significantly reduce or eliminate the incidences of cross contamination.

## Cerumen may be an infectious agent

Cerumen is not considered an infectious agent unless contaminated with blood or mucus, and due to its color and viscosity, visual detection of blood or ear discharge contaminants may be difficult. Therefore, you should treat cerumen as a potentially infectious agent. It is especially important to be mindful of using new tips when testing children and those with weaker immune systems, such as the frail and elderly as they are more susceptible to infections.

## Are disposable ear tips expensive?

Sanibel Supply® offers volume discounts on ear tips. This will often offset the time and cost involved in the ear tip cleaning process.

## Be more cost effective in your clinic

By using a new ear tip pr. every patient, you reach a seal much more reliable than with re-used ear tips. How often have you not been fumbling for minutes before you get a seal with a patient? Using the right ear tip and a fresh one pr. patient ensures you a reliable fit with every patient, meaning you can calculate less minutes for testing a patient and in most cases allow you to have an extra patient pr. day without having stressed out personnel. The cost of using one ear tip pr. patient is far less than what you earn on your next patient, plus you can promote your clinic as taking patient safety and hygiene seriously.

## 6 strong reasons why you should use a new ear tip after each patient:

- 1**  
**You reduce the risk of cross contamination between your patients**  
Unfortunately, it is not possible to be 100% certain that complete decontamination has taken place when cleaning ear tips.
- 2**  
**You minimize the risk of non-sealing ear tips**  
Ear tips degrade over time, which can make it more difficult to attain a good seal, hence leading to less accurate results.
- 3**  
**Your patients avoid allergic reactions from cleaning agent residue**  
Residue from cleaning agents may cause allergic reactions in some patients.
- 4**  
**Your patients will appreciate it**  
Patients feel safer and are more comfortable knowing that new ear tips are being used.
- 5**  
**It's so much easier**  
Cleaning ear tips takes time, so why not give your staff the time to do what really matters?
- 6**  
**It's so much faster**  
A fresh ear tip creates a seal quicker and more reliable, so you do not waste time performing a standard procedure.

## List of abbreviations

<b>ABR</b>	Auditory Brainstem Response	<b>HIF</b>	Hearing Instrument Fitting
<b>AUD</b>	Audiometry	<b>IMP</b>	Impedance
<b>BAL</b>	Balance	<b>OAE</b>	Otoacoustic Emissions



Single patient use only!



Product is not made with natural rubber latex





















































# Selecting the correct ear tip

## Selecting the correct size of ear tip takes practice

In general, flanged or mushroom-shaped ear tips will be used for most testing (Impedance, DPOAE, TEOAE and Automated ABR).

Sometimes, an umbrella-shaped ear tip will be used for performing a quick impedance screening.

The table can be used as a guide to help you select the appropriate ear tip size.

Age	Ear tips inserted against ear canal	Ear tips inserted against entrance of ear canal			Ear tips for Echo-Screen®		Ear tips for AccuScreen®		
0.5 y/o			Green, pediatric				4.0 mm, ANA		3.7 mm, AOT
							4.5 mm, ANA		4.0 mm, AOT
			3-5 mm, flanged		3-6 mm, green		6 mm, green		
		7.5 mm, umbrella		4-7 mm, flanged		6 mm, yellow			
		9 mm, umbrella		5-8 mm, flanged				infant tree, ANA	
10 y/o			mushroom, ANA				mushroom, ANA		4-7 mm, AOT
		10 mm, umbrella		7 mm, mushroom		7 mm, red		7 mm, yellow	
		11 mm, umbrella		8 mm, mushroom		8 mm, blue		8 mm, red	
		13 mm, umbrella		9 mm, mushroom		9 mm, green		9 mm, blue	
				10 mm, mushroom		10 mm, yellow		10 mm, green	
		15 mm, umbrella		11 mm, mushroom		11 mm, red		11 mm, yellow	
	Adults			12 mm, mushroom		12 mm, blue		12 mm, red	
		19 mm, umbrella		13 mm, mushroom		13 mm, green		13 mm, blue	
				14 mm, mushroom		14 mm, yellow		14 mm, green	
				15 mm, mushroom		16 mm, red		16 mm, yellow	
		22 mm, umbrella		19 mm, mushroom		18.5 mm, blue			

## Disposable ear tips

### Disposable Sanibel™ ADI ear tips

For use with the following acoustic immittance instruments and otoacoustic emission systems with CLEAR probe tip: **Amplivox**: all Otowave versions. **Interacoustics**: Titan, AT235, AA220, Eclipse, MTO, Sera, OtoRead II. **MAICO**: easyTymp, touchTymp MI 22, MI 23, MI 24, MI 26, MI 34, MI 44, easyScreen, EroScan Plus.

Alternative to AKR (KR) / IA series: Old MAICO MI-series + RaceCar black probe versions together with adaptor kit (8500430). **GSI**: Novus, TympStar Pro, Corti and Allegro. **Natus**: Zodiac (not 901) and AccuScreen.



#### ADI Assortment Box

Part no.	Description
8511445	Various sizes for tympanometry and OAE
8501572	Screening ear tip kit, various sizes for newborn screening



#### Flanged infant ear tips

Part no.	Description	Unit
8502838	Pediatric (green)	Bag/100 pcs
8012964	3-5 mm (red)	Bag/100 pcs
8012966	4-7 mm (blue)	Bag/100 pcs
8012968	5-8 mm (yellow)	Bag/100 pcs
8502837	Pediatric (green)	Bag/25 pcs
8012963	3-5 mm (red)	Bag/25 pcs
8012965	4-7 mm (blue)	Bag/25 pcs
8012967	5-8 mm (yellow)	Bag/25 pcs

VOLUME DISCOUNT AVAILABLE for minimum orders of 10 bags



ABR

IMP

OAE



Medical grade silicone rubber  
Biocompatible

VOLUME DISCOUNT AVAILABLE for minimum orders of 10 bags



#### Umbrella ear tips

Part no.	Description	Unit
8012986	7.5 mm (green)	Bag/100 pcs
8012988	9 mm (red)	Bag/100 pcs
8012990	10 mm (blue)	Bag/100 pcs
8012992	11 mm (yellow)	Bag/100 pcs
8012994	13 mm (green)	Bag/100 pcs
8012996	15 mm (red)	Bag/100 pcs
8012998	19 mm (blue)	Bag/100 pcs
8013000	22 mm (yellow)	Bag/100 pcs
8012985	7.5 mm (green)	Bag/25 pcs
8012987	9 mm (red)	Bag/25 pcs
8012989	10 mm (blue)	Bag/25 pcs
8012991	11 mm (yellow)	Bag/25 pcs
8012993	13 mm (green)	Bag/25 pcs
8012995	15 mm (red)	Bag/25 pcs
8012997	19 mm (blue)	Bag/25 pcs
8012999	22 mm (yellow)	Bag/25 pcs



IMP

#### Mushroom ear tips

Part no.	Description	Unit
8013002	7 mm (blue)	Bag/100 pcs
8013004	8 mm (yellow)	Bag/100 pcs
8012970	9 mm (green)	Bag/100 pcs
8012972	10 mm (red)	Bag/100 pcs
8012974	11 mm (blue)	Bag/100 pcs
8012976	12 mm (yellow)	Bag/100 pcs
8012978	13 mm (green)	Bag/100 pcs
8012980	14 mm (red)	Bag/100 pcs
8012982	15 mm (blue)	Bag/100 pcs
8012984	19 mm (yellow)	Bag/100 pcs
8013001	7 mm (blue)	Bag/25 pcs
8013003	8 mm (yellow)	Bag/25 pcs
8012969	9 mm (green)	Bag/25 pcs
8012971	10 mm (red)	Bag/25 pcs
8012973	11 mm (blue)	Bag/25 pcs
8012975	12 mm (yellow)	Bag/25 pcs
8012977	13 mm (green)	Bag/25 pcs
8012979	14 mm (red)	Bag/25 pcs
8012981	15 mm (blue)	Bag/25 pcs
8012983	19 mm (yellow)	Bag/25 pcs

VOLUME DISCOUNT AVAILABLE for minimum orders of 10 bags



ABR

IMP

OAE

### Single use ear tips for immittance instruments & OAE screeners

For use with many acoustic immittance instruments and otoacoustic emission systems, including the **MAICO** EroScan, **Interacoustics** OtoRead and **Grason-Stadler** TympStar.



VOLUME DISCOUNT AVAILABLE for minimum orders of 10 bags



ABR

OAE

#### Infant ear tips

Part no.	Description	Unit
8013006	3 mm (yellow)	Bag/100 pcs
8002035	4 mm flanged (red)	Bag/100 pcs

## Disposable ear tips

### IA series ear tips

For use with many acoustic immittance instruments and otoacoustic emission systems, including: **GSI**: TympStar Pro, Allegro, Novus and Corti. **Interacoustics** (clear probe): AT235, AA222 and Titan and Otoread II, MT10. **MAICO**: touchTymp RaceCar, touchTymp MI24, MI26, MI34, MI36, easyTymp. **Madsen/Otometrics**: Zodiac (new), Accuscreen. **Path Medical**: all Sentiero products.



Not available in the EU

### Mushroom ear tips

Part no.	Description	Unit
8520348	3-6 mm (green)	Bag/100 pcs
8520349	6 mm (yellow)	Bag/100 pcs
8520350	7 mm (red)	Bag/100 pcs
8520351	8 mm (blue)	Bag/100 pcs
8520352	9 mm (green)	Bag/100 pcs
8520353	10 mm (yellow)	Bag/100 pcs
8520354	11 mm (red)	Bag/100 pcs
8520355	12 mm (blue)	Bag/100 pcs
8520356	13 mm (green)	Bag/100 pcs
8520357	14 mm (yellow)	Bag/100 pcs
8520358	16 mm (red)	Bag/100 pcs
8520359	18.5 mm (blue)	Bag/100 pcs



### IT Select Series ear tips



Not available in the EU

For use with **Inventis**: Flute, Clarinet, Viola, Timpani. **Resonance**: r16m, r26m, r36m, r15c, r25c, r35c.

Part no.	Description	Unit
8522402	8 mm (green)	Bag/100 pcs
8522403	10 mm (red)	Bag/100 pcs
8522404	12 mm (blue)	Bag/100 pcs
8522405	14 mm (green)	Bag/100 pcs
8522406	16 mm (red)	Bag/100 pcs



### AKR mushroom ear tips

Use with the following acoustic immittance instruments and otoacoustic emission systems with BLACK probe tip from **Interacoustics**: AT235, AA220, Eclipse, MT10, Otoread (I), **MAICO**: Old RaceCar, old MI22-36, MI 22, MI 23, MI 24, MI 26, MI 34, MI 44. **Amplivox**: Otowave (all with white probe). **Madsen/Otometrics**: Capella 2, Zodiac 901, Biologic AuDX Pro (+Flex). **Neurosoft**: Neuro-Audio, **Oscilla**: TSM 300/400 + T800 series. All **GSI** tympanometers from GSI 20 - 39 + Tympstar, Allegro.



Not available in the EU

### Mushroom ear tips

Part no.	Description	Unit
8500570	3-6 mm (yellow)	Bag/100 pcs
8107510	4 mm (red)	Bag/100 pcs
8107511	5 mm (blue)	Bag/100 pcs
8500560	6 mm (green)	Bag/100 pcs
8500550	7 mm (yellow)	Bag/100 pcs
8500540	8 mm (red)	Bag/100 pcs
8500530	9 mm (blue)	Bag/100 pcs
8500520	10 mm (green)	Bag/100 pcs
8500510	11 mm (yellow)	Bag/100 pcs
8500500	12 mm (red)	Bag/100 pcs
8500490	13 mm (blue)	Bag/100 pcs
8107520	14 mm (green)	Bag/100 pcs
8500480	16 mm (yellow)	Bag/100 pcs



### Disposable Sanibel™ AOT and ANA ear tips



VOLUME DISCOUNT AVAILABLE for minimum orders of 10 bags

#### ANA ear tips for Echo-Screen®

For use with **Natus**: Echo-Screen®. **Madsen/Otometrics**: AccuScreen® Classic. **Interacoustics**: Eclipse with pink probe tip

Part no.	Description	Unit
8106363	4.0 mm (blue)	Bag/50 pcs
8106362	4.5 mm (red)	Bag/50 pcs
8106364	5.0 mm (green)	Bag/50 pcs
8106366	Infant tree (yellow)	Bag/50 pcs
8106365	Mushroom (green)	Bag/50 pcs



VOLUME DISCOUNT AVAILABLE for minimum orders of 10 bags

#### AOT ear tips

For use with **Madsen/Otometrics** AccuScreen®, Biologic Bio-logic® AuDX®, **Path Medical**: all Sentiero products

Part no.	Description	Unit
8106367	3.7 mm (yellow)	Bag/50 pcs
8106368	4.0 mm (light green)	Bag/50 pcs
8106369	4.5 mm (light pink)	Bag/50 pcs
8106370	5.0 mm (light blue)	Bag/50 pcs
8106371	4-7 mm (transparent)	Bag/50 pcs



## Disposable ear tips

### Grason & Associates OT & MO select series ear tips



Not available in the EU

#### OT select ear tips w/ triangle holes

Ear tips with triangle holes for use with **Otodynamics** UGD, SND, SGD probes

Part no.	Description	Unit
8102644	4.8 mm (blue)	Bag/100 pcs
8102645	6 mm (green)	Bag/100 pcs
8102646	8 mm (red)	Bag/100 pcs
8102647	10 mm (blue)	Bag/100 pcs
8102648	12 mm (green)	Bag/100 pcs
8102649	14 mm (red)	Bag/100 pcs
8102650	16 mm (blue)	Bag/100 pcs



Not available in the EU

#### OT select ear tips w/two probe holes

Ear tips with two probe holes for use with **Otodynamics** ECP, UGS, SNS, SGS probes.

Part no.	Description	Unit
8102632	3.5 mm (blue)	Bag/100 pcs
8102633	4.5 mm (blue)	Bag/100 pcs
8102634	5.5 mm (blue)	Bag/100 pcs
8102635	6.5 mm (blue)	Bag/100 pcs
8102636	4.8 mm (blue)	Bag/100 pcs
8102637	6 mm (green)	Bag/100 pcs
8102638	8 mm (red)	Bag/100 pcs
8102639	10 mm (blue)	Bag/100 pcs
8102640	12 mm (green)	Bag/100 pcs
8102641	14 mm (red)	Bag/100 pcs
8102642	16 mm (blue)	Bag/100 pcs



Not available in the EU

#### MO select ear tips for Madsen OTOflex

For **MADSEN**® OTOflex™.

Part no.	Description	Unit
8102653	3-6 mm (yellow)	Bag/100 pcs
8102654	6 mm (red)	Bag/100 pcs
8102655	7 mm (blue)	Bag/100 pcs
8102656	8 mm (green)	Bag/100 pcs
8102657	9 mm (yellow)	Bag/100 pcs
8102658	10 mm (red)	Bag/100 pcs
8102659	11 mm (blue)	Bag/100 pcs
8102660	12 mm (green)	Bag/100 pcs
8102661	13 mm (yellow)	Bag/100 pcs
8102662	14 mm (red)	Bag/100 pcs
8102663	16 mm (blue)	Bag/100 pcs
8102664	18 mm (green)	Bag/100 pcs



### Ear tips for OAE screeners

For use with **Biologic AuDx**, **Welch Allyn** OAE screener and **Natus** Echo-Screen® III.



#### OAE ear tips, AuDx

Part no.	Description	Unit
8107885	AuDx Preemie 3 mm	Bag/100 pcs
8107889	AuDx Tree 3.5-5mm	Bag/100 pcs
8107887	AuDx Infant 6 mm	Bag/100 pcs
8102681	Adult OAE foam	Bag/100 pcs
8102682	Pediatric OAE foam	Bag/100 pcs
8103123	Jumbo OAE foam	Bag/100 pcs
8515505	AuDx Preemie 3 mm	Bag/20 pcs
8515506	AuDx Tree 3.5-5mm	Bag/20 pcs
8515507	AuDx Infant 6 mm	Bag/20 pcs
8515436	Adult OAE foam	Bag/20 pcs
8515435	Pediatric OAE foam	Bag/20 pcs
8515438	Jumbo OAE foam	Bag/20 pcs



## Save time pr. patient, earn more money and help more patients!

Use a fresh ear tip pr. patient and be sure to reach a seal right away, when inserting the ear tip. A fresh ear tip contains the optimal conditions for reaching a seal when inserting it into the patients' ear, whereas a multi-used one often will cause you trouble and delay you in your process. By allowing yourself to plan less time pr. patient for testing, you can see more patients pr. day. That is worth much more than cleaning an ear tip, both for your clinic and your patients.

## Probe tips



IMP

### Probe tip for Sanibel™ ADI™ ear tips

Fits all Otowaves, new MT10 and GSI Allegro.

Part no.	Unit
8002592	1 pc



IMP

### Probe tip for Sanibel™ ADI™ ear tips

Fits Titan™ and easyTymp™.

Part no.	Unit
8001701	1 pc



IMP OAE ABR

### Probe tip kit

Fits AT235™ or newer, AA222™, Sera™, Titan vers. 2, Tymptstar Pro™ Novus™, easyScreen™, and touchTymp™. Includes probe tip and gasket.

Part no.	Unit
8501570	Kit/3 pcs



OAE

### Internal probe tip replacements for ERO•SCAN™

Fits ERO•SCAN™.

Part no.	Unit
8102339	Bag/4 pcs



OAE

### ERI0D probe tips for ERO•SCAN™ Pro and OtoRead™

It is recommended to clean the probe tip after every patient and to change the probe tip after 20 tests (40 ears). No re-calibration necessary.

Part no.	Unit
8012836	Bag/4 pcs



OAE

### Internal probe tip replacements for ERO•SCAN™ Pro

Fits ERO•Scan™ Pro.

Part no.	Unit
8120914	Bag/4 pcs



OAE

### Probe tip kit for OAE Ø3.3 mm ear tips

Fits all Eclipse™ – use with ADI™ ear tips. Requires no re-calibration.

Part no.	Unit
8012960	Bag/8 pcs



IMP

### Sanibel™ probe tip adaptor kit

Converts AT235™, AT235h™, AA220™, AA222™ (blue/new), MI24™, MI26™, MI34 old series, MI44™ for use with ADI™ ear tips. Includes probe tip, washer, damper. No re-calibration required.

Part no.	Unit
8500430	Set/3 pcs



OAE

### Remote probe tip replacements for ERO•SCAN™

Fits ERO•Scan™ Classic.

Part no.	Unit
8102340	Bag/4 pcs



### Snap probe accessories

Accessories specifically designed to work with SnapPROBE®. For use with **Interacoustics** Sera, **GrasonStadler** Novus, **Maico** EasyScreen.

Part no.	Description	Unit
8522758	Ear tip Infant A (Conical)	Bag/100 pcs
8522760	Ear tip Infant C (Narrow)	Bag/100 pcs
8522759	Ear tip Infant A (Conical)	Bag/25 pcs
8522761	Ear tip Infant C (Narrow)	Bag/25 pcs
8517889	Probe Waxguard	Set 10 pcs
8516436	Probe Waxguard	1 pc
8522461	Assortment of accessories including Infant tip A and C and waxguard	

2

LATEX

ABR

OAE



## Probe tips

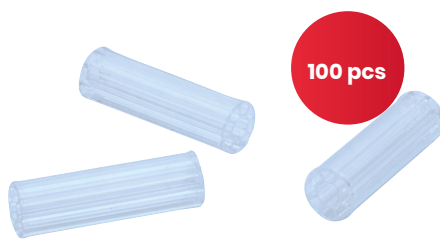

OAE

### Sanibel™ probe tubes for ADI™ ear tips

Fits Corti™, ERO•SCAN™ Plus and the new OtoRead™.

Part no.	Unit
8104159	Box/100 pcs

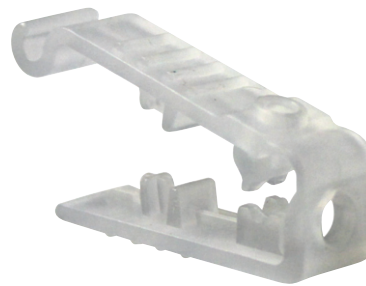

OAE

### Probe Tube Removal Tool

Fits Corti™, ERO•SCAN™ Plus and the new OtoRead™.

Part no.	Unit
8513131	Bag/1 pc

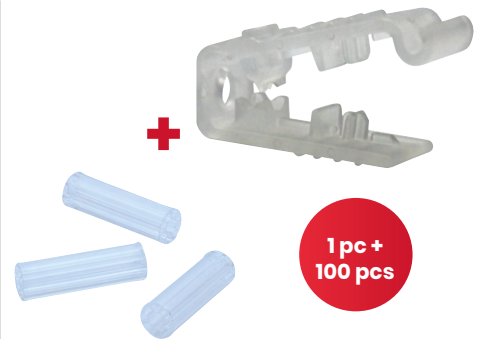

OAE

### Probe Tube Removal Tool kit

Fits Corti™, ERO•SCAN™ Plus and the new OtoRead™.

Part no.	Unit
8513132	Bag/100 pcs + 1 pc

## Sanibel™ Probe Tube Removal Tool

- A = Probe
- B = Probe Tube Installer
- C = Attachment to probe cable
- D = Tube Remover

### To Remove a Probe Tube

1. Place the front hole of the Probe Tube Tool over the end of the probe, as shown. The probe should be seated against the face of the tool and snap in place.
2. Squeeze the tool closed and hold it.
3. Twist the tool a couple of times while holding the tool closed and pulling away from the probe.
4. The probe tube will pull out from the probe. Discard the probe tube.

### To Install a New Probe Tube

5. Place a new tube into the hole on the top of the tool.
6. Align the probe with the tube.
7. Push the probe onto the probe tube until the probe contacts the face of the probe tube tool and a snapping sound is heard.
8. Slide the tool off, leaving the tube in place in the probe.

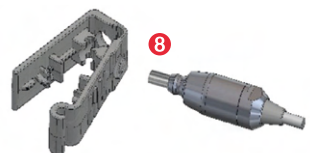
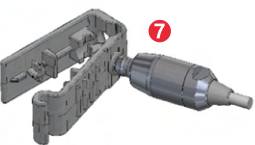
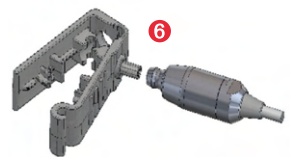
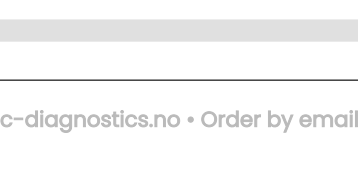
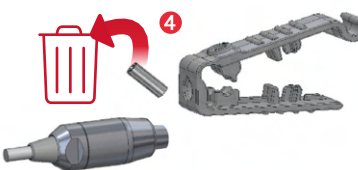
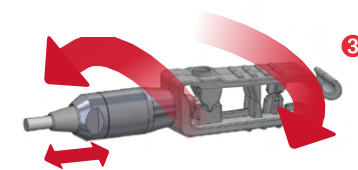
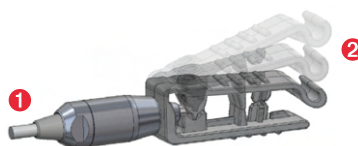
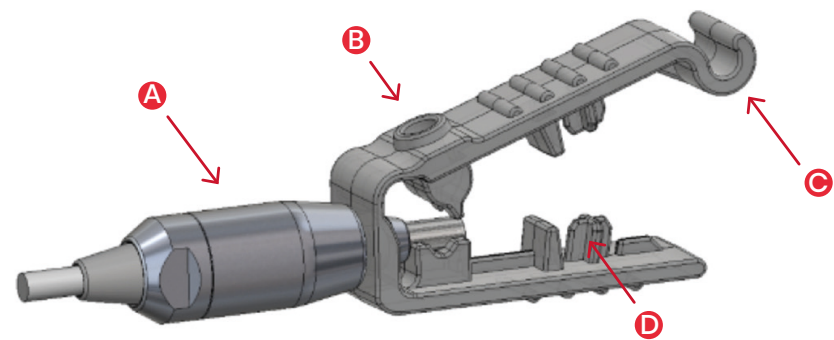

## Supplies for insert earphones



ABR AUD

### Sanibel™ foam tip, small

Compatible with all insert phones.

Part no.	Description	Unit
8527912	Pediatric pink	50 pcs
8527913	Pediatric pink	100 pcs
8527915	Pediatric pink	750 pcs



ABR AUD

### Sanibel™ foam tip

Compatible with all insert phones.

Part no.	Description	Unit
8527918	Adult pink, medium	50 pcs
8527920	Adult pink, medium	100 pcs
8527921	Adult pink, medium	750 pcs



ABR AUD

### Sanibel™ foam tip

Compatible with all insert phones.

Part no.	Description	Unit
8535534	Adult pink, jumbo	24 pcs

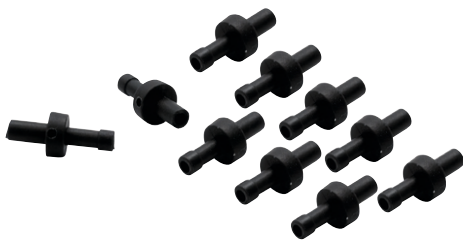

ABR

### Sanibel™ IP30™ tube connectors

For use with IP30™ and E-A-Rtone® 3A.

Part no.	Unit
8107391	Bag/10 pcs



ABR AUD

### Sanibel™ ADI ear tip adaptor

Makes Sanibel™ ADI ear tips compatible with 3A insert phones.

Part no.	Unit
8500580	Bag/6 pcs

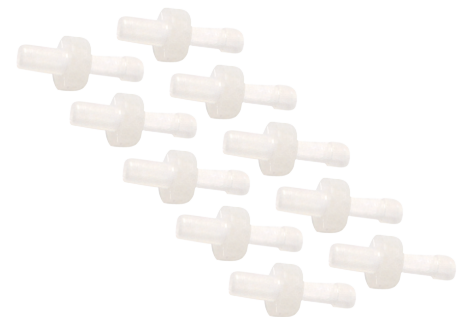

ABR AUD

### Tube nipples for E-A-Rtone® 3A

For use with sound tubes 3A.

Part no.	Unit
8500140	Bag/10 pcs



Not available in the EU



ABR AUD

### 3A E-A-RLINK™ foam ear tips

Complies to all insert phones.

Part no.	Description	Unit
8500090	Adult/Medium size 13.7 mm	Bag/50 pcs
8106226	Adult/Medium size 13.7 mm	Bag/100 pcs



Not available in the EU



ABR AUD

### 3B E-A-RLINK™ foam ear tips

Complies to all insert phones.

Part no.	Description	Unit
8500110	Pediatric/Small size 9.7 mm	Bag/50 pcs
8106227	Pediatric/Small size 9.7 mm	Bag/100 pcs



Not available in the EU



ABR AUD

### 3C E-A-RLINK™ foam ear tips

Complies to all insert phones.

Part no.	Description	Unit
8500100	Jumbo/Large size 17.8 mm	Bag/24 pcs

## Supplies for insert earphones



Not available in the EU

2

ABR

### E-A-RLINK™ infant ear tips

For use with infants or in very small ear canals.

Part no.	Description	Unit
8500300	3.5 mm	Bag/20 pcs
8500310	4.0 mm	Bag/20 pcs



ABR OAE

### Sanibel™ ear tip adaptor cleaning tool

Small brush for cleaning the Sanibel™ probe tip adaptors.

Part no.	Unit
8500830	Bag/10 pcs



ABR

### Sanibel™ fastener kit for IP30™

Includes velcro neckstrap and clip.

Part no.	Unit
8507410	Set

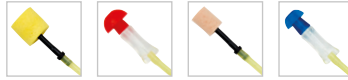

ABR

### Sound tubes for E-A-Rtone® 3A 10 ohm

Includes adaptor nipples.

Part no.	Unit
8107396	Bag/1 pc

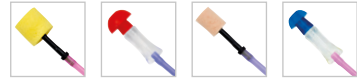
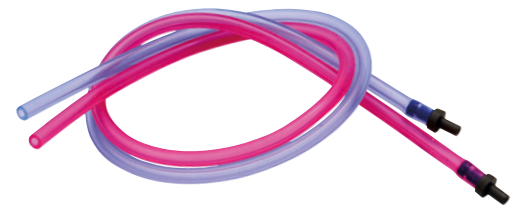

ABR

### Sanibel™ IP30 and E-A-Rtone® sound tubes and nipples

Fit all IP30™ and E-A-Rtone® versions. Includes tube connectors, 1 pc blue and 1 pc red.

Part no.	Unit
8501072	Set/2 pcs

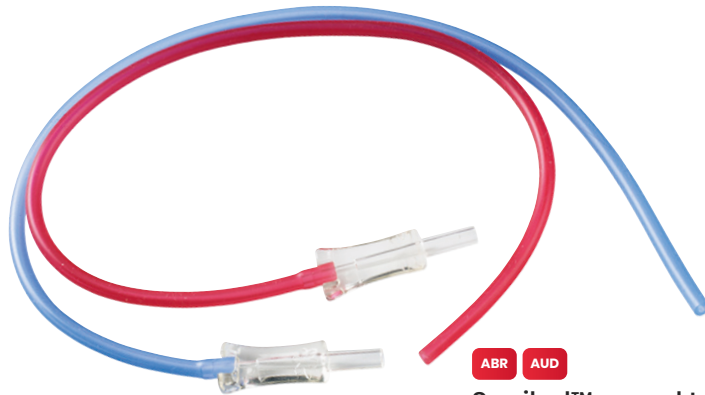

ABR AUD

### Sanibel™ sound tubes and Sanibel™ ADI™ ear tip adaptor kit

Fits E-A-Rtone® 3A inserts and IP30™ insert phones. Includes ADI™ ear tip adaptors, 1 pc blue and 1 pc red.

Part no.	Unit
8100590	Set/2 pcs



NEW

### IP30 Clip

Replacement velcro clip for insert earphones. Compatible with a variety of insert earphones, including: IP30, E-A-Rtone 3A and 5A, Etymotic ER-3A and ER-3C.

Part no.	Unit
8537295	1 pc



100 tests



Not available in the EU

ABR

### ABR consumable kit

Includes electrodes, insert phone tips, skin scrub and gaze.

Part no.	Description	Unit
8109670	Adult 3A	Kit/100 tests
8109671	Pediatric 3B	Kit/100 tests

# Sanibel™ Infant EarCup™ & EARturtle™



Exchange the electrodes with your preferred version!  
**CONTACT US FOR SUPPORT**



ABR

## Sanibel™ Infant EarCup™ with snap or tab electrodes

Reduce test time! Test on both ears in one screening. Compatible with Titan™, AccuScreen® (1st generation), MB II Classic and Echo-Screen®. Use only with equipment calibrated for over-ear style disposables. Disposable over-the-ear earphones are high quality, low cost, and ideal for bilateral newborn hearing screenings. 1 set consists of 2 Infant EarCups™, 3 snap or tab electrodes and 1 alcohol pad.

For use with a range of different providers of newborn hearing screening equipment: **Grason Stadler:** Novus. **Interacoustics:** Titan, Sera. **Maico:** easyScreen, MB II Classic. **Madsen/Otometrics:** Accuscreen. **Natus:** Biologic Abear, Echo-Screen.

Part no.	Description	Unit
8049600	Tab	Box/20 sets
8049700	Snap	Box/20 sets
8508848	w/o electrodes	Box/20 sets

## Sanibel Infant EarCup™ w/ Hydrogel

New Hydrogel version to ensure a more comfortable solution for the baby while testing.

Choose any electrode type you wish to add to meet your preference.

Order electrodes separately.

Part no.	Unit
8516095	Box/20 sets



ABR

## Sanibel™ Infant EarCup™ adaptor set

Connects insert phones with Infant EarCups™. NB: Do not contain filters.

Part no.	Unit
8500450	Set/2 pcs

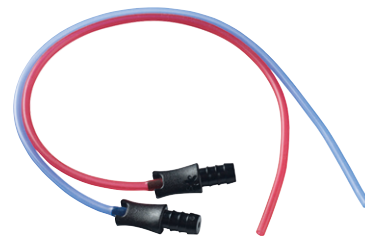

ABR

## Sanibel™ sound tubes and Sanibel™ Infant EarCup™ adaptor kit

Includes adaptors, 1 blue and 1 red tube.

Part no.	Unit
8100577	Set/2 pcs



ABR



Can be used with various equipment for ABR testing

## EARturtle™ disposables ear couplers

For use with a range of different providers of newborn hearing screening equipment: **Interacoustics:** Sera, **MAICO:** easyScreen, MB II Classic, **GSI:** Novus, **Natus:** Echo-Screen, Echo-Screen III, Algo 3i, Algo 5, Algo 7, Biologic Abear.

No recalibration needed for any of the above-mentioned equipment.

Part no.	Description	Unit
8529735	Tab	Box/36 sets
8530442	Snap	Box/20 sets
8522749	w/o electrodes and alcohol pads	Box/20 sets



## EARturtle™ adapter for RadioEar IP30

Part no.	Unit
8515872	1 pc

## Disposable electrodes

Large, soft electrode size!

60 pcs



ABR

### Sanibel™ snap electrodes

Pre-gelled with a very gentle hydrogel, perfect for ABR testing on infants. Size 2.2 x 3 cm. Item no. 8107137 is packed in 20 smaller pouches of 3 electrodes. Intended use areas: Newborn, diagnostic follow-up, ABR, C-Vemp.

Part no.	Unit
8107137	Box/60 pcs (20x3 pcs)

Large, soft electrode size!

60 pcs



ABR

### Sanibel™ tab electrodes

Pre-gelled cloth electrode with a very gentle hydrogel, perfect for ABR testing on infants. Size 2.2 x 3 cm. Packed in 20 smaller pouches of 3 electrodes. Intended use areas: Newborn, diagnostic follow-up, ABR, C-Vemp.

Part no.	Unit
8107410	Box/60 pcs (20x3 pcs)

50 pcs



### Vermed Economy line 3-pack solid gel snap Electrode

Solid gel type snap electrode suitable for diagnostic follow-up. Latex free. Intended use areas: Newborn, diagnostic follow-up all ages.

Part no.	Unit
8516252	Bag/50 pcs



20 pcs

ABR

### Gold Eartip Electrode

For ECoChG. Use with cable 8011343.

Part no.	Description	Unit
8500370	Adult 13 mm	Bag/20 pcs
8500440	Pediatric 10 mm	Bag/20 pcs



10 pcs

ABR

### Sanibel™ TM Electrode

For ECoChG. Use with cable 8500650.

Part no.	Unit
8011489	Box/10 pcs
8049550	Single pc

## Choose the correct electrode for optimal performance

Sanibel Supply® offers various kinds of surface electrodes for ECG as well as EEG and ABR. Surface electrodes vary in size, adhesion, connectivity and frequency (test category).

The frequency plot to the above shows the electrical stimuli sent directly through the system and compared to the surface electrode (here ABR). The two lines are similar and demonstrate that the surface electrode can be used for ABR testing.

**At Sanibel Supply®, we always test and validate our surface electrodes to ensure optimal performance for your testing!**

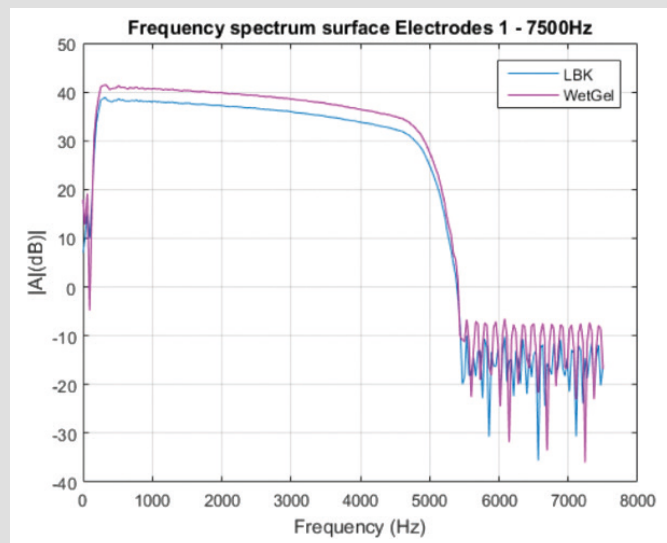

## Disposable electrodes



75 pcs

### Vermed Wetgel Snap Electrode

Pre-gelled hydrogel electrode with Ag/AgCl sensor. Very suitable for diagnostic follow-up. Used for newborn screening, industry-wide. Packaged 3 pcs. per pouch.

Part no.	Unit
8516221	Box/75 pcs



100 pcs

### Vermed Tab Electrode

Rectangular tab electrode used for newborn screening, industry-wide. 12.7 x 22.9 mm. Conductive Adhesive Hydrogel. 10x10 pcs. per pouch.

Part no.	Unit
8516225	Bag/100 pcs



60 pcs

ABR

### Vermed Hydrogel Snap Electrode

Large soft electrode size making it very suitable for newborn screening and ABR measurements. Cloth material makes it convenient to wear. Size 3.4 x 2.2cm.

Part no.	Unit
8516907	Bag/60 pcs (3x20 pcs)



60 pcs

ABR

### Vermed Hydrogel Snap Electrode

Smaller than the rectangular version, but otherwise similar. Good, soft electrode size making it very suitable for newborn screening and ABR measurements. Cloth material makes it convenient to wear.

Part no.	Unit
8102022	Bag/60 pcs (3x20 pcs)



100 pcs

### Vermed Tab Electrode

Rectangular tab electrode used for newborn screening, industry-wide. 22.9 x 34 mm. Conductive Adhesive Hydrogel. 10x10 pcs. per pouch.

Part no.	Unit
8516227	Bag/100 pcs

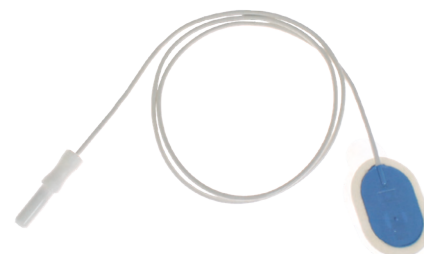

ABR

### Ambu® Blue Sensor™ N-50-K

Part no.	Unit
8521842	Bag/25 pcs



50 pcs

### Vermed Economy Line Snap Wet Gel Electrode

Non-woven cloth electrode with conductive wet gel. Passed ISO 10993 and is Latex free.

Part no.	Unit
8516251	Bag/50 pcs

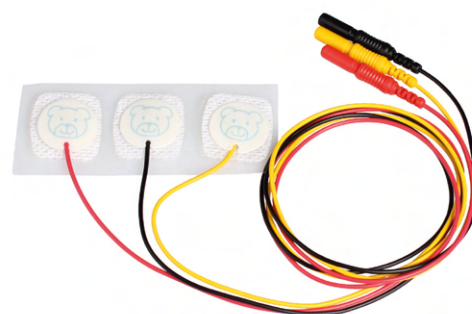

ABR

### Ambu® White Sensor 40554

Part no.	Unit
8520431	Bag/3 pcs



## Disposable electrodes



100 pcs

ABR

### Ambu® 0415M tab electrode

Medium size tab electrode with solid gel for 12-lead ECG. Presented conveniently with 10 pieces to a card. Fish tail tab design reduces electrode lift-offs. Suitable for both adults and children.

Part no.	Unit
8516138	Bag/100 pcs (10x10 pcs)



1000 pcs

ABR

### Ambu® 2300 Blue Sensor Tab electrode

The medium size Ambu BlueSensor 2300 electrode features a skin-friendly solid gel that provides optimal signal quality recordings during 12-lead diagnostic testing ECG application. Very suitable for ABR diagnostics of all kinds.

Part no.	Unit
8516139	Box/1000 pcs (10x100 pcs)



25 pcs

ABR

### Ambu® Blue Sensor™ N-00-S

Foam ECG electrode for use with button cables. Wetgel.

Part no.	Unit
8013029	Bag/25 pcs

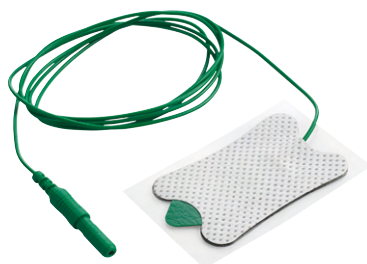

ABR

### Ambu® Ground electrode 7140-M/1

Part no.	Unit
8500680	1 pc



25 pcs

ABR

### Ambu® Neuroline 720

Ambu Neuroline 720 electrodes are pre-gelled and self adhesive. They are ideal for use in sleep registration where the strong, yet skin-friendly, adhesion ensures that the electrode stays in place for the entire examination, even if the patient sweats.

Part no.	Unit
8500060	Bag/25 pcs



50 pcs

ABR

### Ambu® Blue Sensor™ P-00-S

High quality Ag/AgCl sensor – ensures excellent trace quality.

Part no.	Unit
8504782	Bag/50 pcs



ABR

### Ambu® Neuroline 720 - with 100 cm cable and k-connector

Ambu Neuroline 720 electrodes are pre-gelled and self adhesive. They are ideal for use in sleep registration where the strong, yet skin-friendly, adhesion ensures that the electrode stays in place for the entire examination, even if the patient sweats.

Part no.	Unit
8503244	Bag/10 pcs



25 pcs

ABR

### Ambu® Blue Sensor™ N-10-A

Foam ECG electrode with 10 cm wire and 4 mm connector, for use with universal electrode cable. Wetgel.

Part no.	Unit
8500670	Bag/25 pcs



## Electrode cables



ABR

### Tip trode cables

For use with TTE25 gold foil tip trodes. 1.5 mm with touch proof connectors and plated clamp clips. 50 cm long.

Part no.	Unit
8011343	Set/2 pcs

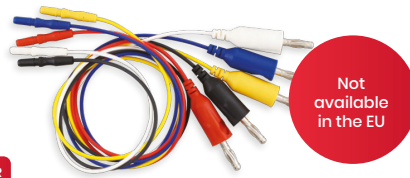

Not available in the EU

ABR

### Universal electrode cable

Available in Red (R), White (W), Blue (B), Yellow (Y), Black (K). 50 cm cable. Non-tangling.

Part no.	Unit
8011353	Set/3 pcs RWB
8011344	Set/5 pcs RWBYK



ABR

### Button electrode cable

For use with snap electrodes. Available in Red (R), White (W), Blue (B), Yellow (Y), Black (K). 50 cm cable. Non-tangling.

Part no.	Unit
8532948	Set/3 pcs RWB
8532949	Set/5 pcs RWBYK



ABR

### Sanibel™ ECoChG starter kit

For Eclipse™ and Bio-logic® AEP system. Includes cable, gel and 2 pcs TM electrodes.

Part no.	Unit
8013209	Set/4 pcs



ABR

### Pinch clip electrode cables

White (W), Yellow (Y), Black (K). Length 100 cm.

Part no.	Unit
8519048	Set/3 pcs WYK



ABR

### Sanibel™ ECoChG cable

For Eclipse™ and Bio-logic® AEP system. 1.5 mm/.060" female connector. For use with Sanibel™ TM electrodes.

Part no.	Unit
8500650	1 pc



ABR

### Ambu electrode cable

76 cm/30".

Part no.	Unit
8518508	1 pc



ABR

### Sanibel™ EP electrode jumper cable

Allows two of the preamplifier inputs to be connected, e.g. for linking mastoid electrodes for cortical testing.

Part no.	Unit
8107872	1 pc

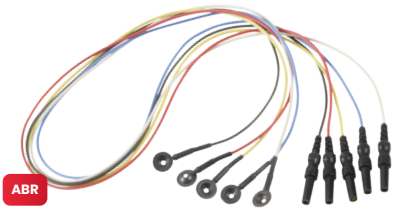

ABR

### Disc electrodes

For use with Ten20™ electrode paste. Available in Red (R), White (W), Blue (B), Yellow (Y), Black (K). 50 cm cable.

Part no.	Unit
8011498	Set/3 pcs RWB
8011345	Set/5 pcs RWBYK

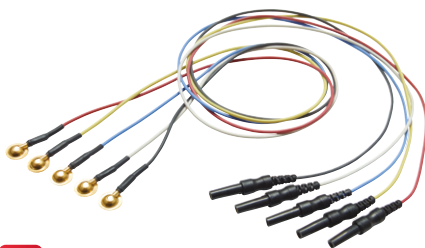

ABR

### Gold-plated cup electrodes

Available in Red (R), White (W), Blue (B), Yellow (Y), Black (K). Ø 10 mm gold-plated. 50 cm cable.

Part no.	Unit
8107418	Set/3 pcs RWB
8107145	Set/5 pcs RWBYK

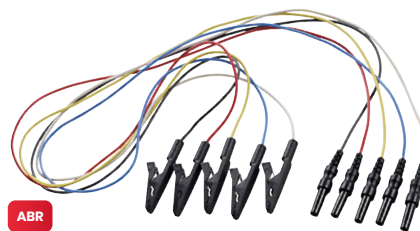

ABR

### Alligator clip cable

For use with tab electrodes. 1.5 mm/.060" female connector. Available in Red (R), White (W), Blue (B), Yellow (Y), Black (K).

Part no.	Unit
8516581	Set/3 pcs RWB
8513776	Set/3 pcs WYK
8516584	Set/5 pcs RWBYK



ABR

### Pinch style cable

For use with snap electrodes. 1.5 mm/.060" female connector. Available in Red (R), White (W), Blue (B), Yellow (Y), Black (K).

Part no.	Unit
8500390	Set/3 pcs RWB
8500400	Set/3 pcs WYK
8500410	Set/5 pcs RWBYK



# Patient preparation



ABR

## Everit™ abrasive paste, 160 g

Reduces the skin impedance during EEG, EP, ECG and Holter Stress test examination.

Part no.	Unit
8012952	Bottle/160 g



ABR

## Sonavelle® electrode gel, 250 ml

Formaldehyde-free and glycerol-free.

Part no.	Unit
8500380	Bottle/250 ml



Not available in the EU

ABR

## 3M™ Red Dot™ trace prep, 5 m

One-step skin preparation. 18 mm x 5 m / 0.70" x 196".

Part no.	Unit
8500030	Dispenser/5 m



12 rolls

Not available in the EU

ABR

## 3M™ Transpore™ Surgical tape, 9.14 m

Transparent, latex-free, water-resistant and porous for breathability. 25 mm x 9.14 m / 1" x 10 LY.

Part no.	Unit
8500750	Box/12 rolls



12 rolls

Not available in the EU

ABR

## 3M™ Micropore™ Surgical tape, 9.14 m

Latex-free and hypoallergenic. Holds well on damp skin. 25 mm x 9.14 m / 1" x 10 LY.

Part no.	Unit
8500760	Box/12 rolls



10 packs

ABR

OAE

## Q-tips

Cotton tipped applicators for patient preparation. Non-sterile. Each pack contains of 100 pcs.

Part no.	Unit
8500810	Box/10 packs



ABR OAE

## Softa® Swabs

70% isopropyl alcohol.

Part no.	Unit
8500050	Box/100 pcs



ABR OAE

## Ambu® 2121M Skin Prep Pads

Part no.	Unit
8523414	Box/500 pcs



ABR OAE

## Gauze swabs

Non-sterile, 7.5 x 7.5 cm and 8 layered.

Part no.	Unit
8500040	Pack/100 pcs



## Patient preparation



ABR

### SignaGel®, 250 g

Bacteriostatic conductive saline electrode gel.

Part no.	Unit
8102628	Tube/250 g



ABR

### Spectra 360® electrode gel, 250 g

Salt- & chloride-free conductive electrode gel suitable for long-term applications.

Part no.	Unit
8500740	Tube/250 g



ABR

### NuPrep™ skin prep gel, 114 g

Efficient, yet gentle skin abrasive. Chloride and acetone free. Pack of 1x4 oz/114 g tube or 3x4 oz/114 g tube.

Part no.	Unit
8500320	Box/3 tubes



ABR

### Ten20™ conductive EEG paste, 114 g/228 g

Adhesive gel for disc electrodes. Available in pack of 3x4 oz/114 g tubes or 3x8 oz/228 g jar.

Part no.	Unit
8012924	Box/3 tubes
8500330	Box/3 jars

## Infection control



### Disposable head covers

Perform high hygiene practices in front of your patients or clients.

Part no.	Unit
8519350	Box/ 100 pcs

### Disposable face masks

Perform high hygiene practices in front of your patients or clients.

Part No.	Description	Unit
8515555	Safety mask with loops	Box/50pcs

### Disposable apron

Keep a professional appearance also after servicing a hearing instrument.

Part no.	Unit
8519348	Box/100 pcs



### Safety goggles

Part no.	Unit
8522417	1 pc



### Nitrile examination gloves

For use at medical sites and at research institutes etc. Do not interact with petroleum oils, grease, solvents. Do not contain latex.

Part no.	Description	Unit
8515551	Small	Box/100 pcs
8515552	Medium	Box/100 pcs
8515553	Large	Box/100 pcs
8515554	Extra large	Box/100 pcs



NEW

### OtoVita® Disinfection Spray, 750 ml

For the disinfection of worktops and ear impressions.

Part no.	Unit
8536605	1 pc



NEW

### OtoVita® Hand Gel, 1l

For hygienic washing of hands.

Part no.	Unit
8536606	1 pc



NEW

### OtoVita® Professional Disinfection Concentrate, 1l

For the disinfection of earmolds and instruments in the ultrasonic cleaning unit.

Part no.	Unit
8530888	1 pc



### 3" Disposable ear cushion cover

Replaces disinfectants. Headphone covers for classic audiometric headphones.

Part no.	Unit
8107419	Box/500 pcs



### Probe cleaning tool

For **Interacoustics** Titan™/AT235™/AA222™/Sera™/MT10™/**Amplivox** Otowaves/**MAICO** touchTymp MI22, MI23, MI24, MI26, MI34, MI36, MI44 + touchTymp™ and **CSI** TympStar™ Pro, Novus and Allegro.

Part no.	Unit
8011351	1 pc



### 3-in-1 floss

Used to clean probe tips.

Part no.	Unit
8003565	Box/100 pcs



### 4.5" Disposable ear cushion cover

Replaces disinfectants. Headphone covers for noise cancelling audiometric headphones. For HDA200/DD450/DD65v2/ Peltor headsets.

Part no.	Unit
8513404	Bag/100 pcs



### Cleaning Wipes

Easy cleaning of surfaces.

Part no.	Description	Unit
8520146	Wipes canister	30 pcs



### Bridge & Implant floss

Used to clean probe tips.

Part no.	Unit
8003566	Box/30 pcs



### Keyboard protective foil

Place a protective foil over your keyboard to minimize contamination with grime, bacteria and germs, or liquid.

Part no.	Unit
8500460	1 pc



### Disinfecting Wipes

Cleaning and disinfecting wipes, specially designed for surfaces, instruments, healthcare seats and medical devices

Microbiological properties:

The solution's specific formulation has virucide actions (according to RKI, BGV and DVV), bactericide actions (as per the EN 13727 standard) and fungicide actions (as per the EN 14562 standard) for a contact time of 1 minute.

The solution is effective on enveloped viruses (coronavirus, HIV, hepatitis).

Part no.	Unit
8525161	Canister with 90 wipes

## REM probe tubes for HA fitting



HIF

### Sanibel™ REM probe tubes, type A

Universal fit, length 76 mm, beveled 45° angle tip and black marker ring. 

Part no.	Unit
8104116	Tray/50 pcs 

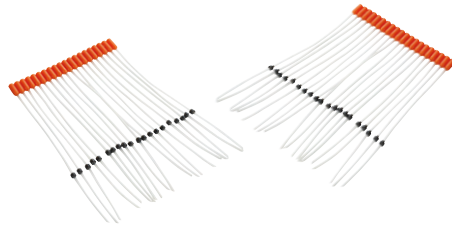

HIF

### Sanibel™ REM probe tubes, type B

Fit all brands, **Interacoustics**, **Natus Aurical**, **MedRx** and **AudioScan**. 

Part no.	Unit
8500360	Bag/40 pcs 



50 pcs

HIF

### Silicone tubes for SPL60™

For use with Affinity™ REM probe. 

Part no.	Unit
8500700	Bag/50 pcs 



NEW

### Sanibel probe tubes, type A

Universal REM Probe Tubes

Part no.	Unit
8533301	50 pcs



NEW

### Sanibel probe tubes, type C

Universal REM Probe Tubes

Part no.	Unit
8533303	50 pcs



NEW

### Sanibel probe tubes, type D

Universal REM Probe Tubes

Part no.	Unit
8533304	50 pcs



# Use Sanibel™ probe tubes for any equipment

We often hear from the industry that only the manufacturers' specific probe tubes should be used with their specific equipment. However, a recent comparative study by Sanibel Supply® disproves this myth.

In this study, our in-house audiologists and engineers compared the effects of different probe tubes on an Affinity<sup>2D</sup> system. They compared AudioScan tubes (red), Otometrics

tubes (blue), Sanibel™ tubes (orange) and Sanibel™ tubes (grey).

This involved running each tube via the 'tube calibration' process and then comparing the following REUG curve when the tube had been left in the calibration position.

The investigation showed no significant difference in the REUG curve and all probe tubes achieved the same result when the calibration process had been run correctly.

**The "REM effect"**  
– better fitting & fewer follow-ups!

Be sure of an individual and ideal fitting

Assurance of your fitting gives you confidence in your work

Confidence increases your credibility and client satisfaction

Client satisfaction means fewer follow-up appointments

## Impression materials and supplies



HIF

### Impression pads, standard, pink

Diameter approx. 1.1 cm, length 1,2 cm. 

Part no.	Unit
8515559	Box/100 pcs

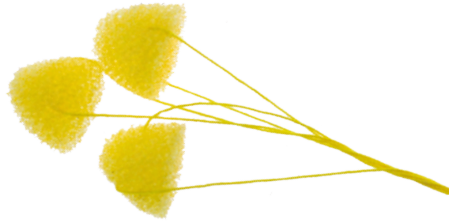

HIF

### Impression pads CIC, Yellow

Diameter approx. 1.1 cm, length 0,7 cm. 

Part no.	Unit
8522182	Box/100 pcs

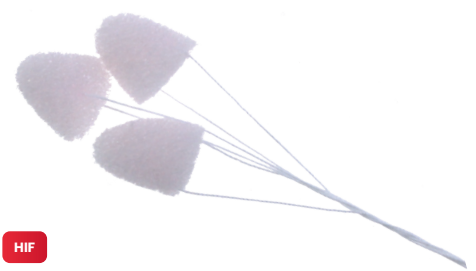

HIF

### Foam Impression Pads, conical, light pink

Diameter approx. 1.25 cm. 

Part no.	Unit
8515560	Bag/100 pcs

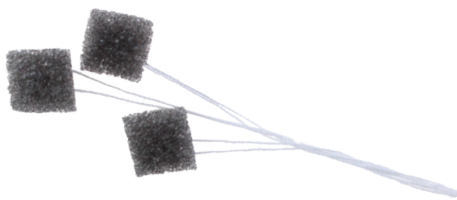

HIF

### Foam Impression Pads Slim, small, grey

Diameter approx. 0.95 cm. 

Part no.	Description	Unit
8515429	Grey	Bag/50 pcs



HIF

### Foam Impression Pads Slim, medium, white

Diameter approx. 1.1 cm. 

Part no.	Description	Unit
8515430	White	Bag /50 pcs

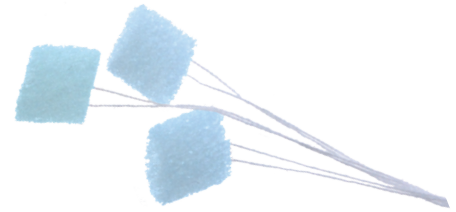

HIF

### Foam Impression Pads Slim, large, blue

Diameter approx. 1.25 cm. 

Part no.	Description	Unit
8515423	Blue	Bag/50 pcs



HIF

### Foam Impression Pads Slim, extra small

Diameter approx. 0.7 cm. 

Part no.	Description	Unit
8527869	white	Bag/50 pcs



HIF

### Cotton Impression Pads, extra small with white safety thread

Part no.	Description	Unit
8527871	White	Bag/50 pcs



HIF

### Cotton Impression Pads, mini with white safety thread

Part no.	Description	Unit
8527870	White	Bag /50 pcs



HIF

### Cotton Impression Pads, small with blue safety thread

Diameter approx. 0.65 cm. 

Part no.	Description	Unit
8515571	Blue	Bag/50 pcs



HIF

### Cotton Impression Pads, medium with white safety thread

Diameter approx. 0.75 cm. 

Part no.	Description	Unit
8515572	White	Bag/50 pcs

## Reasons to maintain high-level skills in the art of ear impressions

The need to maintain the skills within ear impressions using quality products when working with patients is evident. Your patients will thank you for a high level of care and professionalism, long-term. Science and art come together when making a good ear impression. A deep understanding and conscious choice of the types of materials used, combined with the professional desire to be precise and demonstrate great quality and accuracy in your work, will help you make great impressions for each and every one of your patients – regardless of their different ear canal anatomy.

There is a need to be skilled at ear impressions for several other reasons:

- 1- The concept of "patient delight": One of the most frequent components of "delight" is you – the professional. Sanibel Supply agrees with all hearing professionals viewing the skill of impression taking as a critical one that impacts the potential to delight patients.
  - 2- Bad impressions result in bad earmolds or shells, resulting in bad fittings and dissatisfied patients.
  - 3- The opportunity to provide custom solutions for your patient in a non-
- custom world is one of the key benefits of being skilled and proficient at making ear impressions.
- 4- The win-win of demonstrating your professionalism through the care and effort it takes to provide the best impression of anatomy, ear texture, and desired products.
  - 5- There are a lot of other options where we might need an impression, other than when fitting non-custom technology.



### Fotoplast® Lacquer 3

suitable for all hard earmolds. Curing time: 60seconds. Tissue-friendly surface sealing.

Part no.	Description	Unit
8530893	50 ml	1 pc



### Bite blocks

Used to stabilize the jaw for open mouth impressions.

Part no.	Unit
8527849	Bag/100 pcs
8527850	Bag/25 pcs



### Fotoplast® Gel, 20 ml

Light curing repair resin.

Part no.	Description	Unit
8530895	Clear transparent	1 pc
8530896	Opaque H (yellowish)	1 pc



### Manual Impression Gun

Injection.

Part no.	Description	Unit
8522434	For 50 ml double cartridges	1 pc
8522108	For 48 ml double cartridges	1 pc



HIF

### Impression material A-ZOFT

Premium quality and smooth initial consistency. Extremely soft, easy to remove and allows highest impression precision. Final hardness approx. 30Shore A.

Part no.	Unit
8515424	2x800 g jars
8515426	40 foil bags (sets 2x8 g)



### Large Mixing Spatula

Part no.	Unit
8522104	1 pc



### Mixing tray with dosing scale

Part no.	Unit
8522105	1 pc

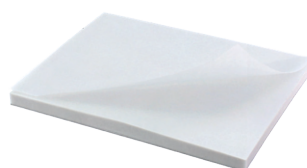

### Mixing pad

Part no.	Unit
8522106	Bag/100 sheets



### Impression Syringe, grey

Easy to fill, inject and clean. Provides a stable and easy injection. 4 mm.

Part no.	Unit
8515445	1 pc

## Impression materials and supplies



### FotoTec® Repair transparent

Light-curing one component resin for repair of ITE shells and BTE earmolds.

Part no.	Description	Unit
8536596	Blue transparent	1 pc
8536597	Clear transparent	1 pc
8536598	Red transparent	1 pc
8536599	Beige opaque 1	1 pc
8536595	Beige opaque 2	1 pc



### Otoform® Ak, Tubs (A+B), inc. dosing spoons, 1box, (2x544ml)

Proven kneadable impression material, non-sticky with slightly pressure forming consistency. Final hardness approx. 35 Shore A.

Part no.	Description	Unit
8528835	2x544 ml	1 pc

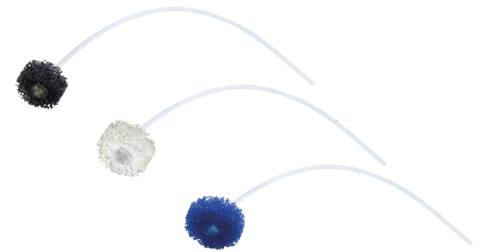

### OtoBlock – Slim PROS® Pressure Relief Oto-Dam System

Part no.	Description	Unit
8536582	9 mm	Bag/24 pcs
8536583	11 mm	Bag/24 pcs
8536584	13 mm	Bag/24 pcs



### Otoform® A flex

Soft, flexible, easy processing. Recommended for CIC impressions, narrow auditory canals or people sensitive to pain. Final hardness approx. 30 Shore A. Included 8 x S 50 double cartridges of 2 x 25 ml A+B.

Note: requires an impression gun and mixing tip.

Part no.	Description	Unit
8522433	50 ml double cartridges	1 pc



### Otoform® Ak

Non-sticky, very pliable impression silicone. Pressure forming. Final hardness approx. 35 Shore A. Note: requires an impression gun and mixing tip. Included 8 x S 50 double cartridges of 2 x 25 ml A+B.

Part no.	Description	Unit
8530889	50 ml double cartridges	1 pc



### Mixing Tips for double cartridge

Part no.	Description	Unit
8522432	Pink, 5,4 mm, 50ml	Bag/100 pcs
8522183	Blue, 6,5 mm, 50 ml	Bag/100 pcs
8522430	5,4 mm, 48 ml	Bag/100 pcs
8522431	6,3 mm, 48 ml	Bag/100 pcs



### Otoform® A soft

Soft, easy processing. Recommended for pressure-free impression taking and for CIC hearing systems. Final hardness approx. 40 Shore A. Note: requires an impression gun and mixing tip. Included 8 x S 50 double cartridges of 2 x 25 ml A+B.

Part no.	Description	Unit
8536593	50 ml double cartridges	1 pc



### Otoform® A softX

Soft, easy processing with optimal fluidity. Recommended for deep ear impressions and sensitive ears. Final hardness approx. 25 Shore A. Note: requires an impression gun and mixing tip. Included 8 x S 50 double cartridges of 2 x 25 ml A+B.

Part no.	Description	Unit
8536594	50 ml double cartridges	1 pc

## Tubing



### Pre-bent Tubing

Quilled on one end for easy insertion into the earpiece and double bent to lie close to the head.

Part no.	Description	Unit
8527852	Standard #12	Bag/25 pcs
8527872	Medium #13	Bag/25 pcs
8527853	Thick #13	Bag/25 pcs
8527854	Extra Thick #13	Bag/25 pcs



### Pre-bent Disappear Tubing

With a long quill for easy insertion into earmold. The tubing is perfectly formed, free from kinking, in flesh colour. Please note, tubing color is not guaranteed. Colour of tubes may vary from pictures.

Part no.	Description	Unit
8527855	Standard #12	Bag/10 pcs
8527856	Medium #13	Bag/25 pcs
8527857	Thick #13	Bag/25 pcs



### Tubing Retention System (TRS)

Designed for all soft earpiece materials. Each TRS tube uses an acrylic ring to hold it in position in the earpiece. TRS tubes are easily replaced and will not tear silicone materials.

Part no.	Description	Unit
8527927	Thick #13	Bag/25 pcs
8527928	Super Thick #13	Bag/25 pcs



### Pre-bent Tubing with Tube Lock

Tubing system that uses a brass retention ring for soft earpieces.

Part no.	Description	Unit
8527860	Thick #13	Bag/10 pcs
8527861	Super Thick #13	Bag/10 pcs



### Pre-bent Stay Dry Tubing

Specially formulated tube helps prevent moisture buildup caused by humidity or perspiration.

Part no.	Description	Unit
8527873	Medium #13	Bag/10 pcs
8527874	Thick #13	Bag/10 pcs



### Tube Lock without tube

Brass tube-lock for use with 13 thick and 13 super thick tubing.

Part no.	Description	Unit
8527858	Thick #13	1 pc
8527859	Super Thick #13	1 pc



### Horn Tube

Uses the horn effect to increase response in the high-frequency range.

Part no.	Description	Unit
8527934	3 mm Medium	Bag/6 pcs
8527930	3 mm Thick	Bag/6 pcs
8527931	4 mm Medium	Bag/6 pcs



### Horn TRS Tubes

Horn TRS tubes use acrylic rings to hold tubes in position. Designed for soft earpiece materials.

Part no.	Description	Unit
8527932	3 mm	Bag/6 pcs
8527933	4 mm	Bag/6 pcs



### Libby Horn

Special tube designed to increase gain over conventional tubing. Ideal when using an analog hearing instrument and fitting a high frequency hearing loss. Also designed to allow for a friction fit into earmold without the need to damage soundbore when removing it.

Part no.	Description	Unit
8515663	4 mm	Bag/10 pcs
8515657	3 mm	Bag/10 pcs



## Tubing



NEW

### Arc Tubing connection with retentions

Part no.	Unit
8530938	Bag 10 pcs



NEW

### Tubing

Part no.	Description	Unit
8530939	Ø 2.0 x 3.0mm	Roll 10 m



NEW

### Pre-bent tubing

Part no.	Description	Unit
8530962	Ø 2.0 x 3.0mm	Bag 10 pc



NEW

### OtoVita Tubing

Designed for all soft earpiece materials. Each TRS tube uses an acrylic ring to hold it in position in the earpiece. TRS tubes are easily replaced and will not tear silicone materials.

Part no.	Description	Unit
8530957	Floss micro	30 pcs
8530958	Floss	30 pcs

## Clinical Tools

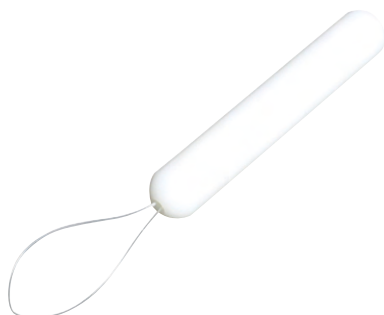

### Tube Puller, Monofilament

Soft and flexible enough to easily slip through the sound bore of an acrylic earpiece, allowing quick and simple tube replacement.

Part no.	Unit
8527877	1 pc

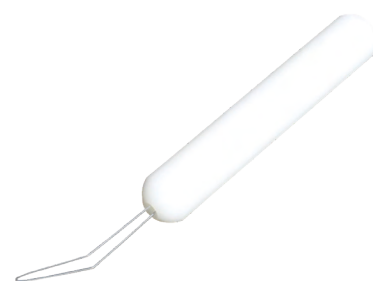

### Tube Puller, Wire Loop

Rigid enough to slip easily through the sound bore of a vinyl or silicone earpiece, allowing quick and simple tube replacement.

Part no.	Unit
8527878	1 pc



NEW

### Reamer for 13 Tube

Part no.	Unit
8536590	1 pc

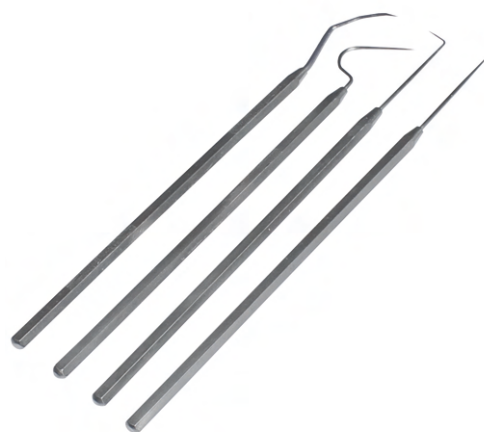

### Probe Set, Stainless steel

For probing, material removal.

Part no.	Unit
8527929	Set of 4 pcs



### Scissors, 3.5"

Sharp scissors suitable for general use in the clinic.

Part no.	Unit
8527905	1 pc



### End Nipper Pliers

A perfect tool for trimming tubing from the end of a canal after the earmold has been retubed.

Part no.	Unit
8527900	1 pc

## Clinical Tools



### Tubing Expander Plier

Stainless steel pliers with two-way lever spring allow you to quickly and easily stretch acoustic tubing before fitting it over earhooks, elbows, etc.

Part no.	Description	Unit
8527875	Curved	1 pc
8527876	Straight	1 pc



### Needle Nose Pliers 5"

Needle nose pliers for a multitude of uses in the hearing healthcare clinic.

Part no.	Unit
8527898	1 pc



### Sprue Cutter, 4.5"

A unique design easily trims tubing flush to the earpiece.

Part no.	Unit
8527935	1 pc



### Tweezers

For a variety of clinical uses. Good for working on hearing instruments and other small parts.

Part no.	Description	Unit
8527902	Curved Point Precision Tweezers 6"	1 pc
8527903	Fine Tipped 4.75" Tweezers	1 pc
8527904	Anti-Magnetic Tweezers 4.25"	1 pc
8536603	Bayonet Tweezers	1 pc



### Precision Screwdriver set

Screwdriver set for making adjustments to hearing instruments or other precision work.

Part no.	Description	Unit
8527896	Four flat-tip screwdrivers and two Phillips tips.	Set/6 pcs
8527897	Six flat-tip screwdrivers, three Phillips tips, one needle-point tip, and one magnet tip.	Set/11 pcs



### Surgical Blades and Handles

Suitable for cutting HA tubing.

Part no.	Description	Unit
8515427	Surgical blade handle No.3	1 pc
8515428	Surgical blades No11	100 pcs



### Excel® Soft Grip Razor Knife

Part no.	Unit
8536589	1 pc



### Alligator Forceps

Standard 5.5" stainless steel alligator forceps with serrated jaw. Not intended for invasive medical procedures.

Part no.	Unit
8527901	1 pc

## Clinical Tools



### Ball burr

Max. rotation speed (min<sup>-1</sup>) 30,000

Part no.	Description	Unit
8530914	Ø 2.1 mm	1 pc
8530915	Ø 3.5 mm	1 pc



### Twist drill

Max. rotation speed (min<sup>-1</sup>) 30,002.

Part no.	Description	Unit
8530929	Ø 1.6 mm	1 pc



### Mirror Go Round

Part no.	Unit
8536591	1 pc



### Superglue, viscous,

Part no.	Unit
8530937	1 pc /10 ml



### Twist drill

Max. rotation speed (min<sup>-1</sup>) 30,000.

Part no.	Description	Unit
8530927	Ø 0.8 mm	1 pc



### Large Twist drill

Max. rotation speed (min<sup>-1</sup>) 30,003.

Part no.	Description	Unit
8530930	Ø 2.85 mm	1 pc



### SK 87 Silicone glue

Part no.	Unit
8532585	1 pc /18 ml



### Twist drill

Max. rotation speed (min<sup>-1</sup>) 30,001.

Part no.	Description	Unit
8530928	Ø 1.2 mm	1 pc



### Demo Ear skin coloured

Part no.	Description	Unit
8536602	Right	1 pc
8536601	Left	1 pc



### Loctite 406 Instant adhesive

An instant adhesive designed especially for the fast bonding of plastics and elastomeric materials where very fast fixturing is required. This product offers exceptionally low viscosity.

Part no.	Unit
8005067	1 unit

## 5 main elements of a comprehensive HA fitting

### 1. Understanding the patient needs and history

A successful HA fitting entails an in-depth discussion of all the issues surrounding their hearing loss, these include: patient concerns, lifestyle and expectations. This needs to be done alongside a thorough medical history. It helps to set the scene.

### 2. Diagnostic audiometry and pre-fitting speech tests

Pure tone audiometry and word recognition testing are standard procedures performed using an Audiometer and the accuracy at this point in the process is of great importance.

### 3. Fitting and verification

Three minimum goals specified for a HA fitting are:

- 1 - to make soft sounds audible,
- 2 - moderate sounds comfortable, and
- 3 - ensuring that loud sounds are not uncomfortable. You can get an objective view of the amplification in the ear using Real Ear Measurements, so you can fully understand what the hearing aid is doing for the patient.

### 4. Counseling and training

Patients should always receive thorough training and guidance in using their hearing aids as it will impact their success in using it as a rehabilitation tool.

### 5. Follow-up care and outcome measures

Post-fitting care is important to confirm if the user is utilizing their hearing aid to its greatest effect. Through discussion with their HCP, adjustments can be made if necessary, so that the user feels the best way possible about their hearing aids and are also given the opportunity to influence their hearing care.



**Earlight with Scaled Top**

Part no.	Description
8519357	Luxamed LED Ear light with acrylic scaled top, black
8519358	Luxamed Acrylic Top with Scale



**Cerumen Removal Tool**

Part no.	Description	Unit
8527907	w/Brush and Magnet	1 pc
8527908	w/Brush	1 pc
8527909		1 pc



**Vent Cleaning Tool**

Part no.	Unit
8527910	1 pc



**Battery Extractor Tool**

Part no.	Unit
8527911	1 pc



**Stethoclip**

Hearing Instrument listening stethoscope for reassuring the fitting process

Part no.	Description	Unit
8515600	Stethoclip, black	1 unit
8520346	Ear funnels	1 unit
8520347	ITE Adaptor	1 unit



**Stethoclip with coupling**

Part no.	Description	Unit
8530897	Stethoclip	1 pc
8530900	ITE adaptor with tubing	1 pc



**Mini Cleaning Brush**

Clean hearing instruments in an easy way.

Part no.	Unit
8519100	1 pc



**LED Earlite**

The 18 Lumens light is concentrated in a small tip that fits most ears. Includes 2 AAA batteries.

Part no.	Unit
8527868	1 pc



**LED Earlite Tips**

To be used with LED Earlite 8527868.

Part no.	Description	Unit
8527862	Straight	Bag/4 pcs
8527863	Pros	Bag/4 pcs
8527864	Scoop	Bag/4 pcs
8527865	Steel loop (S and L)	Bag/2 pcs

## Take care of your hearing aids

Take good care of your hearing aid. Your Hearing instrument is a high tech device needing regular care in order to provide you the best performance every day.



### Cleansing tablets

Part no.	Unit
8520148	Pk/4 pcs



### Dehydrating capsules

Part no.	Unit
8520149	4 pcs



### Drying cup

Part no.	Unit
8520150	1 pc



### Cleaning cup

Part no.	Unit
8520151	1 pc



### Otofloss

Part no.	Unit
8520152	1 pc



### Perfect Dry LUX box for all types of hearing aids

Part no.	Unit
8520154	1 pc



### Starter kit

Part no.	Unit
8520155	1 kit



### Drying spray

Part no.	Unit
8520153	1 pc



### Earmold Air Blowers

Part no.	Unit
8515562	1 pc

## Hearing aid maintenance and care



### Cleaning spray

Part no.	Unit
8520147	1 pc



### Cleaning wipes

Part no.	Unit
8520146	Pk/30 pcs



### Protect your ears

Part no.	Description	Unit
8520053	Dermoprotective Gel	1 pc



### Protect your ears

Part no.	Description	Unit
8520063	Earspray	1 pc



### Protect your ears

Part no.	Description	Unit
8520052	Natural lubricant	1 pc



Available in different languages ask us for details

### Sanohra Earplugs - Swim

Sanohra Swim earplugs, suitable for children and adults. Prevent water from getting into the ear canal and protect ears when exposed to water.

Part no.	Description	Unit
8519353	EarPlugs Swim Kids, EN	1 set
8520143	EarPlugs Swim Adult, EN	1 set



Available in different languages, ask us for details

### Sanohra Earplugs - Fly

Sanohra Fly earplugs, suitable for children and adults. Reduces ear pressure experiences when flying.

Part no.	Description	Unit
8519351	EarPlugs Fly Kids, EN	1 set
8519352	EarPlugs Fly Adult, EN	1 set

## Cerumen Management accessories



### Bionix® Safe Ear Currettes

Bionix® Safe Ear Currettes allow healthcare providers to safely and gently remove cerumen with styles to match different types of wax and personal preference. Bionix® Safe Ear Currettes are flexible, to reduce injury to the ear canal, making them safer than stainless steel currettes. Seven color coded tip styles to meet specific needs, giving you “the right tool for any job” for every cerumen situation. Also available as a variety pack.

Part no.	Description	Unit
8515585	Green MicroLoop®	50 pcs/box
8515586	Orange ControLoop®	50 pcs/box
8515587	Red AngleLoop®	50 pcs/box
8519359	Purple VersaLoop®	50 pcs/box
8519360	Blue InfantScoop®	50 pcs/box
8519372	Yellow CeraSpoon®	50 pcs/box
8519361	White FlexLoop®	50 pcs/box
8519362	Variety Kit, (10 each style & 15 white)	

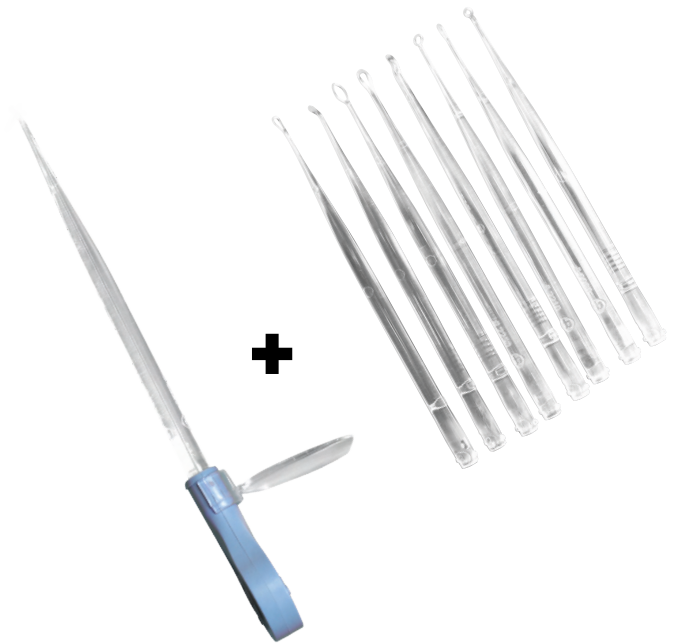

### Bionix® Lighted Ear Currettes

Bionix® Lighted Ear Currettes combine illumination and magnification to help healthcare providers take less time to see and safely remove cerumen from the ear canal. The Lighted Ear Curette with magnification brilliantly illuminates the ear canal, eliminating the practice of blindly curettaging the sensitive area. Complete visualization shortens procedure time and increases efficacy. Box of 50 pcs.

All versions include 1 Light Source and 1 magnifying lens.

Part no.	Description
8519364	Lighted AngleLoop®, 4mm diameter
8519365	Lighted MicroLoop®, 3mm diameter
8519366	Lighted WaveCurette™, 2.5mm wide tip
8519367	Lighted FlexLoop®, 4mm wide tip
8519368	Lighted CeraSpoon®, 4mm wide tip
8519369	Lighted InfantScoop®, 2mm wide tip
8519373	Lighted VersaLoop®, 3mm wide tip
8519370	Lighted CeraPik™, 2.5mm concave tip. Great for hard, impacted cerumen and foreign bodies.



### Why does ear wax accumulate?

Disruption of the self-cleaning mechanism of the ear causes cerumen to accumulate, causing different problems within our ears. These can be related to e.g. general health of the ear as well as hearing.

Anatomical variations, infectious or dermatological diseases can cause narrowing or obstruction of the ear canal. This can then interfere with the normal migratory process of foreign agents from the ear.

### Indications for treatment and treatment options

When symptomatic, cerumen accumulation requires treatment. Usually, ear wax is defined as impacted, if it disrupts visualization of the tympanic membrane, as well as being connected with symptoms.

Often, removal of the cerumen is also done to allow a needed view of the tympanic membrane, e.g. for diagnostic purposes and audiometry.

The first-line option for treatment of

symptomatic cerumen in patients is cerumenolytics (softening agents, e.g. eardrops). The use of cerumenolytic agents, such as eardrops, increase the probability of cerumen clearance.

Patients with heavier impaction or ear canal disease may require irrigation or manual removal under microscope by a trained doctor or an ENT specialist.



### Lighted Ear Curette Variety Pack

Part no.	Description
8519363	With 1 light source and magnifying lens. Includes 8 pcs. of the Lighted Flexloop and 7 pcs. of each of the other styles (not including Cerapik).



### Lighted Forceps

Bionix Lighted Forceps combine illumination and magnification to help healthcare providers take less time to see and safely remove ear canal and nasal passage obstructions.

Part no.	Description
8519392	10 forceps, 1 light and 1 magnifying lens



### OtoClear® Spray Wash Kit

OtoClear Ear Irrigation system gently directs water to the ear canal wall with three divergent streams, instead of directly at the Tympanic Membrane.

Part no.	Description
8519371	Kit of 20x irrigator tips, 1x 470ml spray wash bottle, 1x ear basin
8519390	Otoclear Ear Basin, Box/3 pcs

### Otoclear Irrigation Tips

Bionix OtoClear Ear Irrigation helps provide safe and comfortable ear irrigation without the backsplash, at half the cost of a self-constructed device.

Part no.	Unit
8519375	Box/40 pcs



### EarWay Pro – Wax Removal Helix

Very easy and safe way to remove ear wax. The helix grabs around the ear wax lump and pulls it out in a comfortable way. Available in different languages, please contact us for details.

Part no.	Description	Unit
8518025	Pro M, 5,4 mm, purple	25 units
8518024	Pro S, 4,2 mm, blue	25 units
8521854	Pro L, 6,5 mm, green	25 units





## Parts for audiometry



AUD

### USB cables A to B

Part no.	Description	Unit
8011241	2 m/6.56 feet	1 pc
8011243	5 m/16.40 feet	1 pc



AUD

### DD45/TDH replacement cable

Single, mono. 2 m cable and 6.3 mm/ 30° jack plug.

Part no.	Description	Unit
8507205		1 pc



AUD

### RadioEar DD45 transducer

Audiometric earphones engineered to match the performance and function of the most popular earphones available for audiological testing. 10 ohm receiver. Easy installation. Reliable. RoHS compatible.

Part no.	Unit
8507268	1 pc

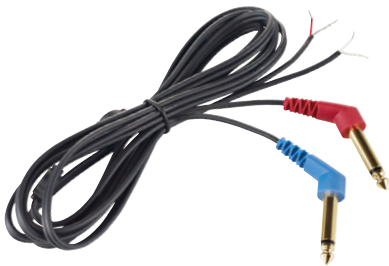

AUD

### HDA200 replacement cable, symmetric

For HDA200 and DD65 headphones. 2 m cable and 6.3 mm/ 30° jack plug.

Part no.	Description	Unit
8004172	30 degree jack. 2m	1 pc



AUD

### IP30 Contra Insert earphone cable

Cable length: 2 m. Plug type: 30°, 1x6.3 mm gold-plated mono jack.

Part no.	Unit
8528812	1 pc



AUD

### DD 51 cushion

For DD45™ and TDH39™ headsets.

Part no.	Unit
8507206	1 pc



AUD

### Replacement cable for old version of B-71

2 m cable and 6.3 mm/ 30° jack plug.

Part no.	Unit
8508473	1 pc



AUD

### DD45™/TDH39™ replacement cable, symmetric

For TDH39™ and DD45™. 30° jack plug.

Part no.	Description	Unit
8507203	2 m	1 pc
8507204	5 m	1 pc

AUD

### Sanibel™ TDH39/DD45 earphone cushion red & blue, model 51

For TDH39, 49, 50 & DD45 earphones.

Part no.	Unit
8507196	1 Set



## Parts for audiometry



AUD

### RadioEar Foldable audiometric headband

Black, foldable.

Part no.	Unit
8010882	1 set



AUD

### RadioEar RE-7 Headband

Black.

Part no.	Unit
8537014	1 set



AUD

### RadioEar DD45 Audiometric headset

Headband: RE-7. Transducer: DD45. Cable length: 2 m. Plug type: 30°, 2x6.3 mm gold-plated mono jack.

Part no.	Unit
8010954	1 set



AUD

### RadioEar DD65 v2 Audiometric headset and transducer

Passive attenuation audiometric headset P4712.

Part no.	Unit
8520330	1 set



AUD

### RadioEar DD45 Adult audiometric headset

Headband: HB3045. Transducer: DD45. Cable length: 2 m. Plug type: 30°, 2x6.3 mm gold-plated mono jack.

Part no.	Unit
8105268	1 set



AUD

### RadioEar DD45 Adult audiometric headset

Headband: HBA, foldable. Transducer: DD45. Cable length: 2 m. Plug type: 30°, 2x6.3 mm gold-plated mono jack.

Part no.	Unit
8106340	1 set

## Parts for audiometry



AUD

### Foam pad for contra headset

Compatible with e.g. TDH39c™ and DD45c™.

Part no.	Unit
8507292	Bag/10 pcs



AUD HIF ABR

### RadioEar replacement pads (3288-1)

For RadioEar Spring Steel headband.

Part no.	Unit
8504777	Bag/10 pcs



AUD HIF ABR

### RadioEar AMBAND bone conductor headband (P1188)

For adult, children and infants.

Part no.	Unit
8507214	Bag/10 pcs



AUD

### Headband cushion

For RadioEar HBA foldable audiometric headband.

Part no.	Unit
8010886	1 pc



AUD HIF ABR

### RadioEar Spring Steel headband (P3333)

Part no.	Unit
8507213	1 pc

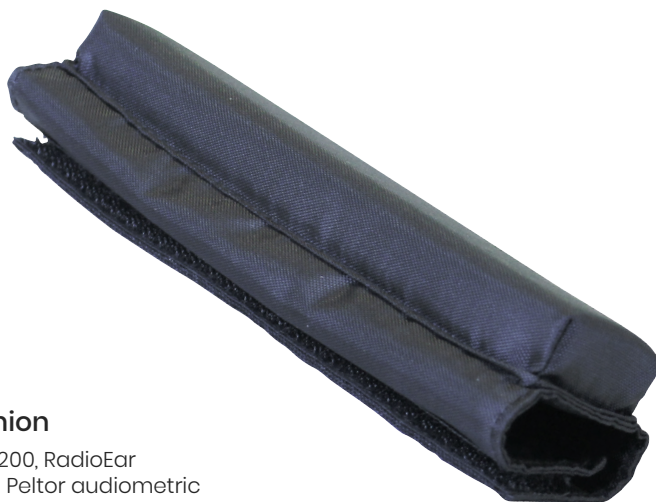

AUD

### Headband cushion

For Sennheiser HDA200, RadioEar DD450, DD65v2 and Peltor audiometric headbands.

Part no.	Unit
8000770	1 pc



### Replacement cable for bone conductor B71/B81 (with safety fixation point)

Part no.	Unit
8515713	1 pc

## Balance supplies

24 pcs



BAL

### Disposable VNG goggle foam pads

For **Interacoustics**® VNG mask.

Part no.	Unit
8011527	Box/24 pcs 



### Paper Kidney tray

Part no.	Unit
8520139	1 pc



34 pcs



### Disposable ear specula

For AirFx™.

Part no.	Description	Unit
8013013	2.75 mm	Bag/34 pcs
8013014	4.25 mm	Bag/34 pcs

50 pcs

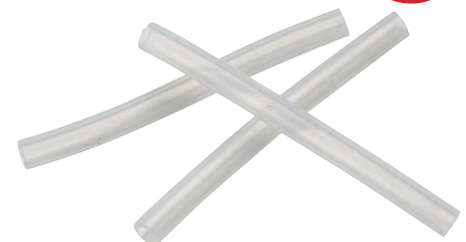

### Water irrigator tips

For use with **Interacoustics**® Aqua Stim™.

Part no.	Unit
8013018	Bag/50 pcs 

# Paper



**VOLUME DISCOUNT AVAILABLE** for minimum orders of 10 rolls

OAE

## Thermal paper for ERO•SCAN™/OtoRead™, 25 m

Width: 57 mm  
Inner diameter: 12 mm  
Outer diameter: 45 mm

Part no.	Unit
8500200	1 roll/25 m



**VOLUME DISCOUNT AVAILABLE** for minimum orders of 10 rolls

IMP

## TPR10™ thermal paper for MTP10™, 25 m

Width: 79 mm  
Inner diameter: 12 mm  
Outer diameter: 45 mm

Part no.	Unit
8500220	1 roll/25 m



IMP

## Thermal paper LPQ80, 80 m

For **gsi** TympStar™ Pro.  
Width: 80 mm  
Inner diameter: 13 mm  
Outer diameter: 80 mm

Part no.	Unit
8509893	1 roll/80 m



**VOLUME DISCOUNT AVAILABLE** for minimum orders of 10 rolls

ABR IMP OAE

## API300 thermal paper for Titan™, 10 m

Width: 57 mm  
Inner diameter: 12 mm  
Outer diameter: 35 mm

Part no.	Unit
8500230	1 roll/10 m



ABR IMP OAE

## Sanibel™ MPT-III thermal paper, 20 m

For Sanibel™ MPT-III printer which is supplied with **Interacoustics**® AT235™.

Width: 79 mm  
Inner diameter: 12 mm  
Outer diameter: 45 mm

Part no.	Unit
8500610	1 roll/20 m

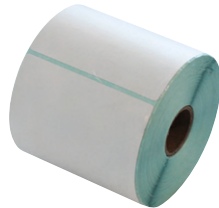

IMP

## Adhesive thermal paper LPQ80, 195 labels

For **gsi** TympStar™ Pro.  
Width: 82 mm  
Inner diameter: 25 mm  
Outer diameter: 88 mm

Part no.	Unit
8509894	1 roll/195 labels



## For OtoRead™ PRT MPT-II printer, 10 m

Width: 57 mm  
Inner diameter: 8 mm  
Outer diameter: 30 mm

Part no.	Unit
8013009	1 roll/10 m



**VOLUME DISCOUNT AVAILABLE** for minimum orders of 10 rolls

IMP OAE

## Thermal paper for Sanibel™ MPT-II printer, 20 m

For the Sanibel™ MPT-II printer which is supplied with **MAICO**® ERO•SCAN™, **Grason-Stadler**® Corti™ and **Interacoustics**® OtoRead™.

Width: 57 mm  
Inner diameter: 9 mm  
Outer diameter: 40 mm

Part no.	Unit
8029305	1 roll/20 m



AUD IMP

## TPR26™ thermal paper for Interacoustics®, 25 m

Fits most popular audiometers and tympanometers.

Width: 112 mm  
Inner diameter: 12 mm  
Outer diameter: 45 mm

Part no.	Unit
8500210	1 roll/25 m



## Label paper roll HM-E200

Label size:  
Width: 56 mm,  
Length: 60 mm  
R angle: 2

Roller size:  
Paper width: 57 mm  
Label spacing: 6 mm  
Core diameter: 13 mm  
Roller diameter: less or equal to 40 mm

Part no.	Unit
8519836	1 roll/120 labels

# Otoscopy Supplies

Heine/  
KaWe  
100 pcs

Welch  
Allyn  
250 pcs



No sharp  
edges

AUD IMP



## Otoscope specula

Disposable ear speculums for Heine/KaWe and Welch Allyn otoscopes size 2.5 and 4 mm.

Part no.	Description	Unit
8507618	4 mm Speculum Economy for Heine/KaWe	100 pcs
8507594	2.5 mm Speculum Economy for Heine/KaWe	100 pcs
8514367	4 mm Speculum for Heine/KaWe	100 pcs
8514368	2.5 mm Speculum for Heine/KaWe	100 pcs
8514369	4 mm Speculum Genuine for Heine/KaWe	50 pcs
8514370	2.5 mm Speculum Genuine for Heine/KaWe	50 pcs
8107750	2.5 mm Speculum for Welch Allyn	250 pcs
8108252	4 mm Speculum for Welch Allyn	250 pcs



AUD IMP

## Luxamed Otoscope Auris LED 2.5V

Otoscope from German Luxamed. LED light to ensure longevity and great light source, dimable. Fits Heine/KaWe compatible speculums.

Part no.	Unit
8519433	1 pc

## Luxamed Otoscope Auris LED 3.7V USB/PC Charged

Otoscope from German Luxamed. LED light to ensure longevity and great light source. USB charging. Fits Heine/KaWe compatible speculums.

Part no.	Unit
8519434	1 pc

50 pcs



No sharp  
edges

AUD BAL IMP

## Disposable speculas for video otoscope

Fits the AURICAL™ OTOcam 300, **Interacoustics**® VIOT and XION™ video otoscopes.

Part no.	Unit
8500470	Bag/50 pcs



No sharp  
edges

100 pcs

AUD BAL IMP

## Video Oscopes specula

Fits the new **Interacoustics**® Viot and OriVision otoscope.

Part no.	Description	Unit
8515083	KaWe 2.5 mm speculum	Bag/100 pcs
8511728	KaWe 4 mm speculum	Bag/100 pcs

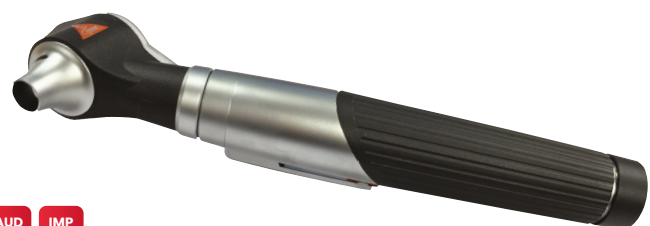

AUD IMP

## HEINE® Mini3000® Otoscope

Classic pocket otoscope from Heine in Germany.

Part no.	Unit
8108833	1 pc

## Batteries and various items



HIF

### Ear coupler sealing wax

Use to create a seal between coupler and hearing instrument.

Part no.	Unit
8500080	1 pc



### Accessories for Otoscopy

Replacement bulb for Heine mini3000 Otoscope.

Part no.	Description	Unit
8515448	Replacement bulb	1 pc

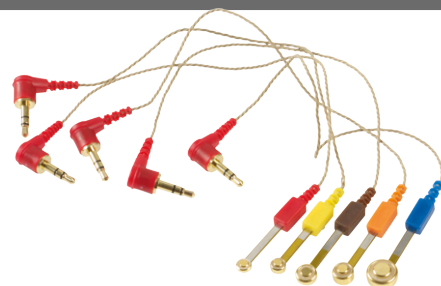

HIF

### Battery adaptor

For **Interacoustics** Affinity™, Callisto™, Equinox™, **MedRx** Avant Hit+ and **Siemens** UNITY 2.

Part no.	Description	Unit
8011198	BAA675	1 pc
8011199	BAA13	1 pc
8011200	BAA312	1 pc
8011201	BAA10	1 pc
8011202	BAA5	1 pc



HIF

### Hearing Instrument batteries Rayovac

Fits all types of Hearing Instruments.

Part no.	Description	Unit
8520134	Rayovac Extra Zap 10	6 pcs
8520135	Rayovac Extra Zap 13	6 pcs
8520136	Rayovac Extra Zap 312	6 pcs
8520137	Rayovac Extra Zap 675	6 pcs



HIF

### Battery accessories

Fits all types of Hearing Instruments.

Part no.	Description	Unit
8515452	Battery tester	1 pc
8520138	Battery "carrier"	1 pc

### Accessories for Otoscopy

Stylish wall dispenser for ear funnels. Can contain 6 different sizes.

Part no.	Description	Unit
8515678	Specula wall dispenser	1 pc



New

### Bulb for Heine mini-c earlight

Part no.	Unit
8530892	1 pc

### Aidapter for hearing aid fitting

Clear Silicone Acoustics couplers. A unique silicone piece that clicks onto the HA-1 adapter.

You can use the Aidapter with receiver-in-canal (RIC) and thin tube hearing aids.

Compared to acoustic putty, the Aidapter™ provides a good acoustic seal and standardizes the coupling, ensuring repeatable coupler measurements.

The Aidapter™ also eliminates the hassle and hygienic issues of using acoustic putty.

Part no.	Description	Unit
8525568	Interacoustics	Bag/3pcs
8525578	MedRx	Bag/3pcs



5 pcs

### EARNimals®

Cartoon faces that are placed on the otoscope. Make ear examinations more fun for kids.

Part no.	Unit
8011501	Bag/5 pcs (assorted)



New

### Heine® Otoscope Hard Case

Part no.	Unit
8536592	1 pc



To order, please go to our website [www.diatec-diagnostics.no](http://www.diatec-diagnostics.no), send us an email at [ordre@diatec-diagnostics.no](mailto:ordre@diatec-diagnostics.no), or contact your local diagnostic instrument distributor.

© Sanibel Supply A/S – 8506431 – INT – Rev. 10 – 01/2024

Oticon AS avd. Diatec • [info@diatec-diagnostics.no](mailto:info@diatec-diagnostics.no) • [www.diatec-diagnostics.no](http://www.diatec-diagnostics.no)

**Sanibel**  
**Supply**

**Disclaimer**

This catalogue has been published for worldwide distribution. Some parts described may NOT BE AVAILABLE in your area. Your local distributor will be pleased to give you details. For advice on compatibility and instructions of use, please consult your operation manual or local distributor. Sanibel Supply A/S assumes no legal liability or responsibility for the accuracy, typing errors or mistakes, correctness or completeness of any information in this flyer. The information in this flyer was correct to the best of our knowledge at the time of printing. Sanibel Supply A/S reserves the right to make changes at any time in specification of products described in this flyer without notice or obligation. MADSEN AccuScreen® and MADSEN OTOflex® are registered trademarks of Otometrics A/S. Echo-Screen®, AuDx®, Navigator® Pro, and ABAer® are registered trademarks of Natus Medical Incorporated. Sanibel® is a registered trademark of Sanibel Supply®. All other instrument brands or model names are copyrighted or trademarked by their respective owners and are used only for reference.