

Instructions for use

BTE

Oticon Geno



Model overview

This booklet is valid for Oticon BTE in the following hearing aid models:

- Oticon Geno 1
- Oticon Geno 2

BTE is available in the below fitting levels:

- Fitting level 85
- Fitting level 100 (Power instrument)

Introduction to this booklet

This booklet guides you in how to use and maintain your new hearing aid. Please read the booklet carefully including the **Warning section**. This will help you to achieve the full benefit of your new hearing aid.

Your hearing care professional has adjusted the hearing instrument to meet your needs. If you have additional questions, please contact your hearing care professional.

| **About** | [Start up](#) | [Handling](#) | [Options](#) | [Warnings](#) | [More Info](#) |

For your convenience this booklet contains a navigation bar to help you navigate easily through the different sections.

Intended use

The hearing aid is intended to amplify and transmit sound to the ear, and thereby compensate for impaired hearing within mild to severe-to-profound hearing loss. This hearing aid is intended for use by adults and children older than 36 months.

IMPORTANT NOTICE

The hearing aid amplification is uniquely adjusted and optimised to your personal hearing capabilities during the instrument fitting performed by your hearing care professional.

Table of contents 1/2

About		
	Identify your hearing aid style and earpiece	10
	BTE with sound hook and mould	12
	BTE with thin tube (Corda miniFit)	14
	Identify left and right hearing aid	16
	Battery	17
Start up		
	Turn the hearing aid on and off	18
	When to replace a battery	19
	Replace the battery	20
Handling		
	Caring for your hearing aid	22
	Brush for cleaning and handling batteries	23
	Sound hook with mould	24
	Put on the hearing aid with mould	25
	Clean the mould	26
	Wash the mould	27
	Thin tube (Corda miniFit)	28
	Put on the hearing aid with thin tube	29
	Clean the thin tube	30
	Standard earpieces: dome or Grip Tip	32
	Replace dome or Grip Tip	33
	Thin tube with Micro mould or LiteTip	34
	Clean Micro mould or LiteTip	35
	Replace ProWax filter	36
Options		
	Optional features and accessories	38
	Mute the hearing aid	39
	Change programs	40
	Change volume	42
	Tamper-resistant battery drawer	44
	Wireless accessories	46
	Other options	48

Continues on next page

Table of contents 2/2

Warnings

Warnings	50
----------	----

More info

Troubleshooting guide	56
Water resistant	58
Conditions of use	59
Warranty certificate	60
International warranty	61
Technical information	62

Identify your hearing aid style and earpiece

There are two different attachments and several different earpieces which classify your hearing aid style. Please identify your attachment and earpiece. This will make it easier for you to navigate through this booklet.

- BTE with sound hook and mould**
A hearing aid with a sound hook will have a mould as earpiece.

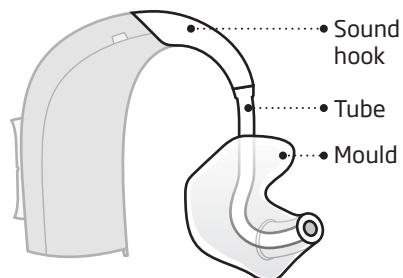

- BTE with thin tube (Corda miniFit)**

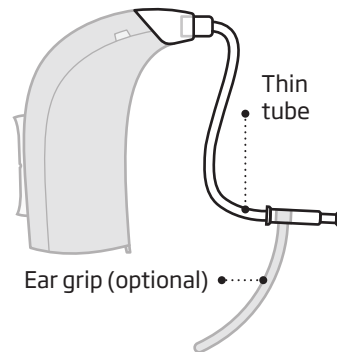

Earpieces

A hearing aid with a thin tube will have one of the following earpieces:

- Dome (open dome shown)*
- GripTip*
- Micro mould or LiteTip

* Please see details for replacing the dome or Grip Tip in section: "Replace dome or Grip Tip".

BTE with sound hook and mould

What it is

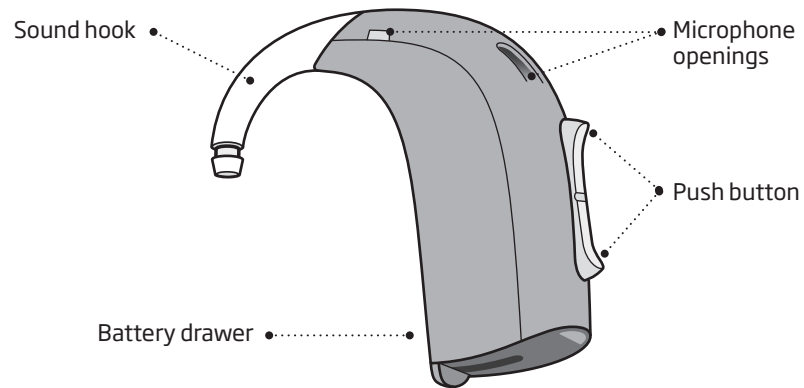

What it does

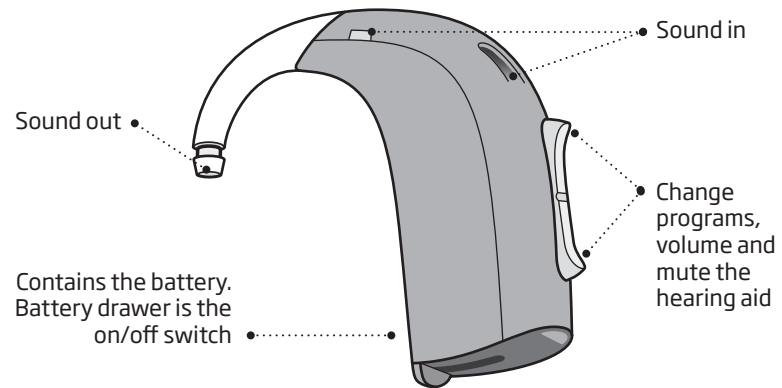

BTE with thin tube (Corda miniFit)

What it is

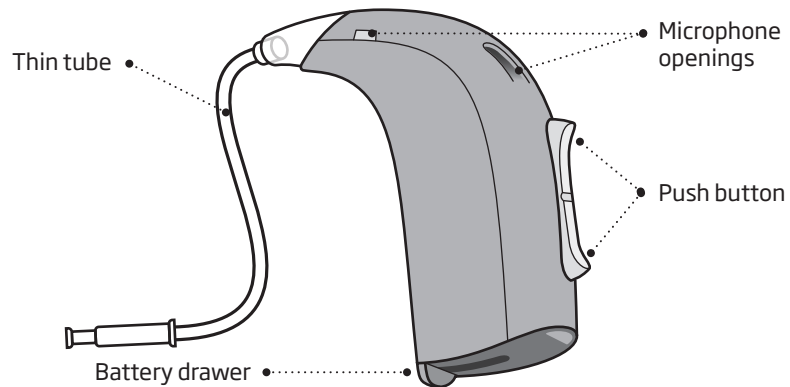

What it does

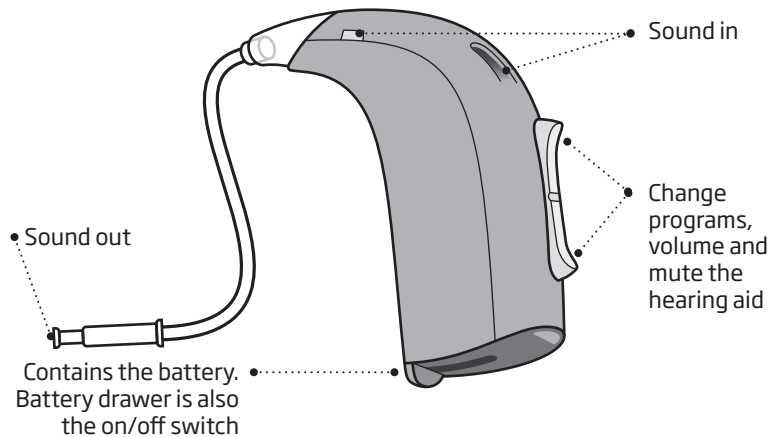

Identify left and right hearing aid

It is important to distinguish between the left and the right hearing aid as they might be programmed differently.

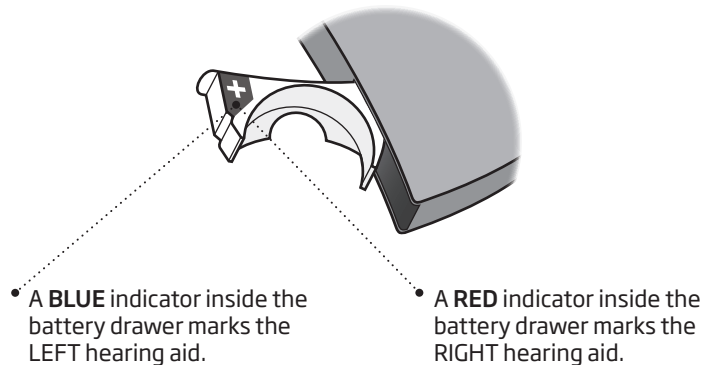

Battery

Your hearing aid is a miniature electronic device that runs on special batteries. To activate the hearing aid, you must insert a new battery in the battery drawer. See how in the “Replace the battery” section.

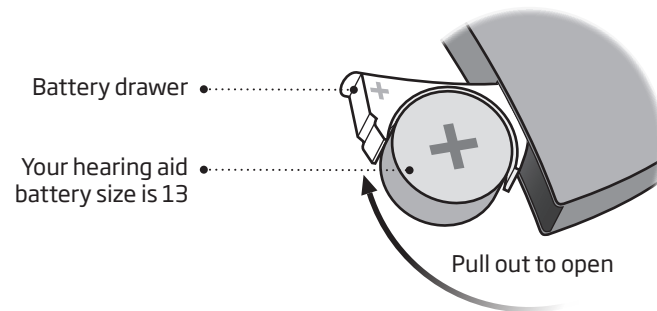

Turn the hearing aid on and off

The battery drawer is also used to switch the hearing aid on and off. To preserve the battery, make sure your hearing aid is switched off when you are not wearing it.

Turn ON
Close the battery drawer with the battery in place.

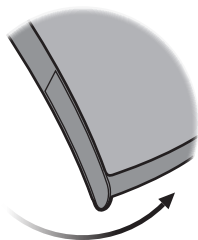

Turn OFF
Open the battery drawer.

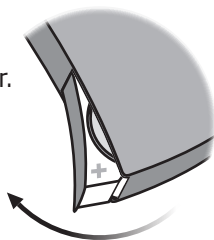

When to replace a battery

When it is time to replace the battery you will hear two beeps repeated in moderate intervals until the battery runs out.



Two beeps
= The battery is running low



Four beeps
= The battery has run out

Battery maintenance tip

To make sure the hearing aid is always working bring spare batteries with you, or replace the battery before you leave home.

Replace the battery

1. Remove

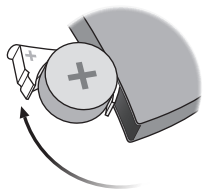

Fully open the battery drawer. Remove the battery.

2. Uncover

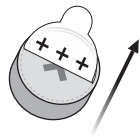

Remove the sticky label from the + side of the new battery.

3. Insert

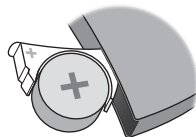

Insert the new battery into the battery drawer. Make sure the + side faces up.

4. Close

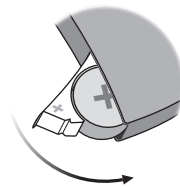

Close the battery drawer. The hearing aid will play a jingle through the earpiece. Hold the earpiece close to your ear to hear the jingle.

Tip

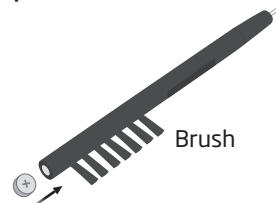

The brush can also be used for battery change. Use the magnetic end to remove and insert batteries.

The brush is provided by your hearing care professional.

Caring for your hearing aid

When handling your hearing aid, hold it over a soft surface to avoid damage if you drop it.

Clean the microphone openings

Carefully brush away debris from the openings. Gently brush the surface. Make sure the brush is not pressed in to the openings.

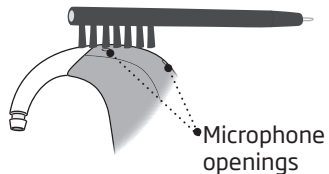

IMPORTANT NOTICE

Use a soft, dry cloth to clean the hearing aid. It must never be washed or immersed in water or other liquids

Brush for cleaning and handling batteries

The brush contains a magnet which makes it easier to replace the battery in the hearing aid. It also contains a wire loop for cleaning and removing ear wax. If you need a new brush, please contact your hearing care professional.

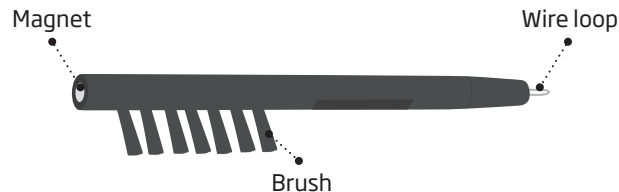

IMPORTANT NOTICE

The brush has a built-in magnet. Keep the brush at least 30 cm away from credit cards and other magnetically sensitive devices.

Sound hook with mould

Read the following pages if you have a hearing aid with a sound hook and a mould.

The mould is customised for you and fits your ear.



Put on the hearing aid with mould

Step 1



Gently pull your ear outwards and press the mould in the direction of the ear canal, twisting slightly.

Step 2



Place the hearing aid behind your ear.

Clean the mould

The mould should be cleaned regularly. Use a soft cloth to clean the surface of the mould. Use the wire loop on the brush to clean the opening.

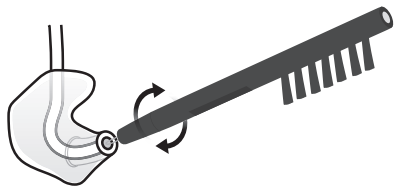

Replace the tube

The tubing between the mould and the hearing aid should be replaced when it becomes yellow or stiff. Consult your hearing care professional in relation to this.

Wash the mould

Step 1



Make sure you are able to identify which mould is for which hearing aid before disconnecting them from the hearing aids.

Step 2



Disconnect the tube and mould from the hook. Hold the hook firmly, when pulling off the tube. Otherwise the hearing may be damaged.

Step 3

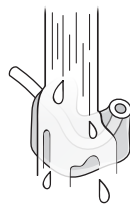

Wash the mould and tube using mild soap. Rinse and dry completely before reconnecting to the hearing aid.

Thin tube (Corda miniFit)

Read the following pages if your hearing aid has a thin tube (Corda miniFit) with either a dome, GripTip, Micro mould or LiteTip earpiece.

Corda miniFit is a thin tube that brings the sound into your ear. The thin tube should always be used with an earpiece attached. Use only parts designed for your hearing aid.

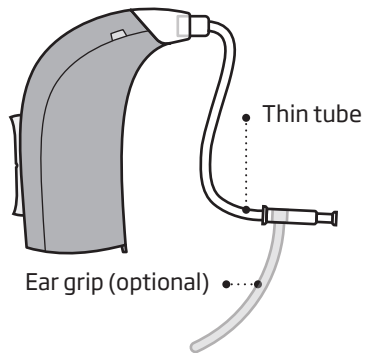

Put on the hearing aid with thin tube

Step 1

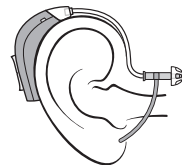

Place the hearing aid behind your ear.

Step 2

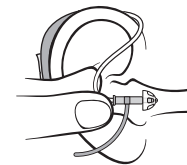

Hold the bend of the tube between your thumb and index finger. The earpiece should point towards the ear canal opening.

Step 3

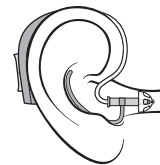

Gently push the earpiece into your ear canal until the thin tube sits close against the side of your head.

Clean the thin tube

The thin tube should be cleaned to keep it clear from moisture and wax. If not cleaned it could become blocked with wax which means no sound will be able to come out.

Step 1

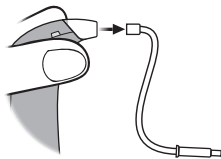

Pull the thin tube out of the hearing aid.

Step 2

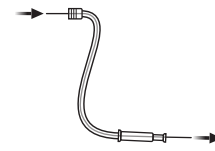

Push the cleaning tool all the way through the thin tube.

Step 3

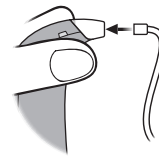

Reconnect the thin tube to the hearing aid.

Standard earpieces: dome or Grip Tip

Both domes and Grip Tip are made of soft rubber material. There are 4 different types of domes. Check your dome type and size below.

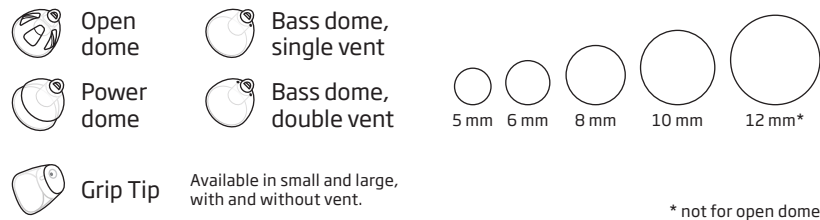

IMPORTANT NOTICE

If the earpiece is not on the speaker when removed from the ear, the earpiece might still be in the ear canal. Consult your hearing care professional for further instructions.

Replace dome or Grip Tip

The standard earpiece (dome or Grip Tip) should not be cleaned. If the earpiece is filled with wax, replace it with a new one (typical weekly). Grip Tips should be replaced at least once a month.

Step 1

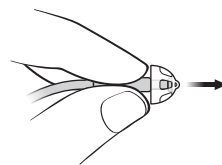

Hold on to the end of the thin tube and then pull off the dome.

Step 2

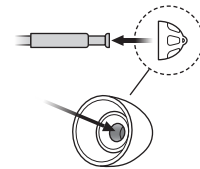

Insert the thin tube exactly into the middle of the earpiece to obtain a secure attachment.

Step 3

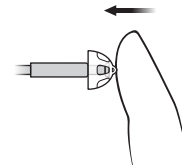

Push firmly to ensure that the dome is fastened securely.

Thin tube with Micro mould or LiteTip

Read the following pages if you have a Micro mould or LiteTip earpiece. Micro mould and LiteTip are customised for your ear shape.



• Micro mould



• LiteTip

Clean Micro mould or LiteTip

The earpiece should be cleaned regularly.

The wax filter in the earpiece should be replaced when clogged or when the hearing aid does not sound normal.



Vent •

Wax filter •

IMPORTANT NOTICE

Always use the same type of wax filter as was originally supplied with the hearing aid. If you are in any doubt about the use or replacement of wax filters, contact your hearing care professional.

Replace ProWax filter

1. Tool

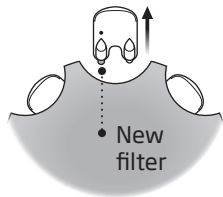

Remove the tool from the shell. The tool has two pins, one empty for removal and one with the new wax filter.

2. Remove

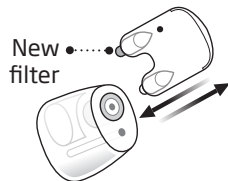

Push the empty pin into the wax filter in the Micro mould and pull it out.

3. Insert

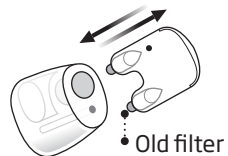

Insert the new wax filter using the other pin, remove the tool, and throw it out.

Optional features and accessories

The features and accessories described on the following pages are optional. Please contact your hearing care professional to find out how your hearing aid is programmed.

If you experience difficult listening situations, a special program may be helpful. These are programmed by your hearing care professional.

Write down any hearing situations in which you may need help.

Mute the hearing aid

Use the mute function if you need to silence the hearing aid.

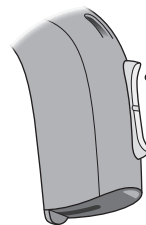

Apply a very long press to either end of the button to mute the hearing aid.
To reactivate the hearing aid, push the button briefly.

IMPORTANT NOTICE

Do not use the mute function as an off switch, as the hearing aid still draws current from the battery in this mode.

Change programs



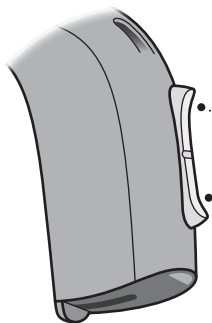

Your hearing aid can have up to 4 different programs. These are programmed by your hearing care professional.



Press up or down between programs

Note that you can change continuously between programs - both up and down in the program order. If for example you want to go from program 1 to 4, you can press the down button once instead of pressing the up button 3 times.

To be filled out by the hearing care professional

Program	Sound you will hear when activated	When to use
1	 "1 beep"	
2	 "2 beeps"	
3	 "3 beeps"	
4	 "4 beeps"	

Program change:

LEFT

RIGHT

Short press

Long press

Change volume

The push button allows you to adjust the volume.
You will hear a click when you turn up or down the volume.

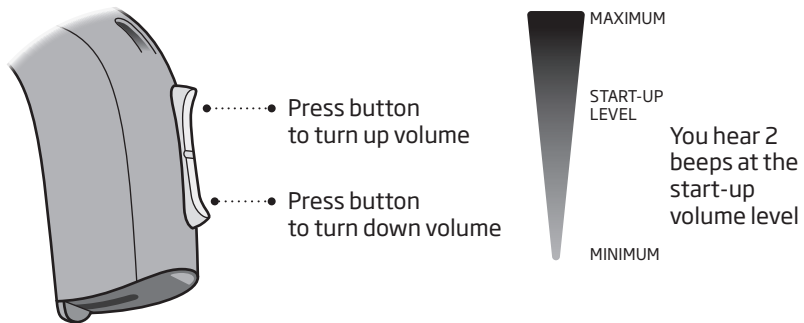

To be filled out by the hearing care professional

Volume change	<input type="checkbox"/> LEFT	<input type="checkbox"/> RIGHT	<input type="checkbox"/> Short press
---------------	-------------------------------	--------------------------------	--------------------------------------

Quick reset

If you wish to return to the standard settings of the hearing aid programmed by your hearing care professional, simply open and then close the battery drawer.

Open

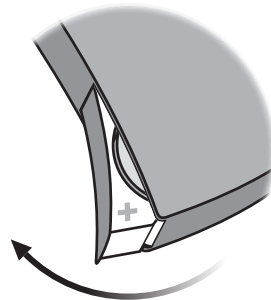

Close

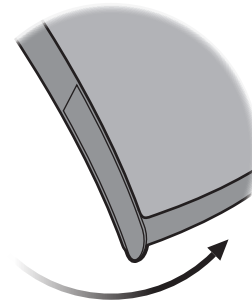

□ Tamper-resistant battery drawer

To keep the battery out of reach of infants, small children and people with learning difficulties, a tamper-resistant battery drawer should be used. Use a small screwdriver to lock and unlock the drawer.

IMPORTANT NOTICE

Avoid excessive force to open the battery drawer when in the locked position. Do not force the battery drawer beyond its fully opened position. Make sure to insert the battery correctly.

Please contact your hearing care professional if you suspect the tamper-resistant effectiveness and locking ability is damaged.

Unlock the battery drawer

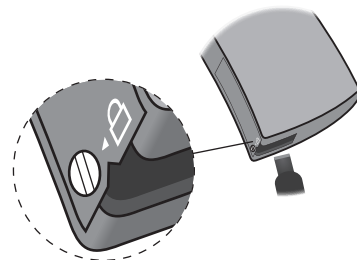

Use the screwdriver to turn the screw to unlock position (vertical). Insert the screwdriver into the slit in the bottom of the hearing aid and push the door open.

Lock the battery drawer

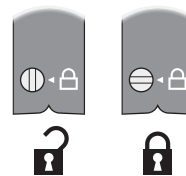

Make sure the drawer is completely closed. Turn the screw to the locked position (horizontal).

Wireless accessories

As an enhancement to your wireless hearing aid a broad range of wireless accessories are available.

ConnectLine

ConnectLine is a family of products that allows you to receive audio signals from TVs, phones, music players, PCs or an external microphone wirelessly through your hearing aid.

Remote Control

Remote Control offers the ability to change program, adjust volume or mute your hearing aid.

FM

Your hearing aid supports the option of attaching an FM system. The FM system allows you to receive speech or audio signals directly to your hearing aid from a dedicated transmitter.

For detailed information on wireless accessories contact your hearing care professional or visit **www.oticon.global**

Other options



Telecoil

helps you hear better when using a telephone with a built in loop or when you are in buildings with teleloop systems such as theatres, churches or lecture rooms. This symbol or a similar sign is shown wherever a teleloop has been installed.



Autophone

is a program that will automatically be activated when your telephone has a built in teleloop (see above). A magnet needs to be placed at your telephone next to the sound outlet.

Direct Audio Input (DAI)

allows your hearing aid to receive signals directly from external sources such as TV, radio, music players, etc. The DAI adaptor is mounted to your hearing aid and via a cable connected to an external sound source.

For detailed information on these options contact your hearing care professional or visit www.oticon.global

IMPORTANT NOTICE

When the DAI is connected to an audio source plugged into a wall outlet, the audio source must comply with IEC-60065, IEC-60601 or equivalent safety standards.

Warnings

You should familiarise yourself fully with the following general warnings before using your hearing aid for your personal safety and to ensure correct use.

Please note that a hearing aid will not restore normal hearing and will not prevent or improve a hearing impairment resulting from organic conditions. Furthermore, note that in most cases, infrequent use of a hearing aid does not permit a user to attain full benefit from it.

Consult your hearing care professional if you experience unexpected operations or events with your hearing aid.

Usage of hearing aids

Hearing aids should be used only as directed and adjusted by your hearing care professional. Misuse can result in sudden and permanent hearing loss.

Never allow others to wear your hearing aid as incorrect usage could cause permanent damage to their hearing.

Choking hazards & risk of swallowing batteries

Hearing aids, their parts, and batteries should be kept out of reach of children and anyone who might swallow these items, or otherwise cause injury to themselves.

Batteries have occasionally been mistaken for pills. Therefore, check your medicine carefully before swallowing any pills.

Most hearing aids can be supplied with a tamper-resistant battery drawer upon request. This is strongly recommended for infants, small children and people with learning difficulties.

Children younger than 36 months must always use a tamper-resistant battery drawer. Please talk to your hearing care professional about the availability of this option.

If a battery or hearing aid is swallowed, see a doctor immediately.

Battery use

Always use batteries recommended by your hearing care professional. Batteries of low quality may leak and cause bodily harm.

Never attempt to recharge your batteries and never dispose of batteries by burning them. There is a risk that the batteries will explode.

Warnings

Dysfunction

Be aware of the possibility that your hearing aid may stop working without notice. Keep this in mind when you depend on warning sounds (e.g. when you are in traffic). The hearing aids may stop functioning, for instance if the batteries have expired or if the tubing is blocked by moisture or ear wax.

Active implants

The hearing aid has been thoroughly tested and characterised for human health according to international standards for human exposure (Specific Absorption Ratio - SAR), induced electromagnetic power and voltages into the human body.

The exposure values are well below international accepted safety limits for SAR, induced electromagnetic power and

voltages into the human body defined in the standards for human health and coexistence with active medical implants, such as pacemakers and heart defibrillators.

If you have an active brain implant, please contact the manufacturer of your implantable device for information about the risk of disturbance.

The Autophone magnet and brush (which has a built-in magnet) should be kept at least 30 cm away from the implant, e.g. do not carry it in a breast pocket.

X-ray, CT, MR, PET scanning and electrotherapy

Remove your hearing aid before X-ray, CT/MR/PET scanning electrotherapy, surgery etc. as your hearing aid may be damaged when exposed to strong electromagnetic fields.

Heat and chemicals

The hearing aid must never be exposed to extreme heat e.g. left inside a parked car in the sun.

The hearing aid must not be dried in microwave ovens or other ovens.

The chemicals in cosmetics, hairspray, perfume, aftershave lotion, suntan lotion and insect repellent can damage the hearing aid. Always remove your hearing aid before applying such products and allow time to dry before use.

Power instrument

Special care should be exercised in selecting, fitting and using a hearing aid where maximum sound pressure capability exceeds 132 dB SPL (IEC 711), as there may be risk of impairing the remaining hearing of the hearing aid user.

For information on whether your hearing aid is a power instrument, see the back of this leaflet.

Warnings

Possible side effects

Hearing aids, moulds or domes may cause an accelerated accumulation of ear wax.

The otherwise non-allergenic materials used in hearing aids may in rare cases cause a skin irritation or other side effects.

Please seek consultation with a physician if these conditions occur.

Interference

The hearing aid has been thoroughly tested for interference, according to the most stringent international standards. However, interference between the hearing aid and other devices (e.g. some mobile telephones, citizens band systems and shop alarm systems and other devices) may occur. If this occurs, increase the distance between the hearing aid and the interfering device.

Connection to external equipment

The safety of the hearing aid when connected to external equipment (via auxiliary input cable or directly), is determined by the external equipment. When connected to external equipment plugged into a wall outlet, this equipment must comply with IEC-62368 (or IEC-60065, IEC-60950 until June 20, 2019) or equivalent safety standards.

Troubleshooting guide

Symptom	Possible causes	Solutions
No sound	Worn-out battery	Replace the battery
	Clogged tube or earpieces (mould, dome, GripTip, Micro mould or LiteTip)	Clean mould Clean Corda miniFit (thin tube), replace dome or GripTip or replace wax filter
Intermittent or reduced sound	Clogged sound outlet	Clean mould Clean Corda miniFit (thin tube), replace dome or GripTip or replace wax filter
	Moisture	Wipe battery with a dry cloth and/or dry tube
	Worn-out battery	Replace the battery
	Clogged damping filter in sound hook	Contact your hearing care professional for assistance
Squealing noise	Hearing aid earpiece inserted incorrectly	Re-insert earpiece (mould, dome, GripTip, Micro mould or LiteTip)
	Ear wax accumulated in ear canal	Have ear canal examined by your doctor

If none of the above solutions work, consult your hearing care professional for assistance.

Water resistant

Your hearing instrument is water resistant which means it is designed to be worn in all daily life situations. Therefore you do not have to worry about sweat or getting wet in a rain shower. Should your hearing instrument come in contact with water and stop working, please follow these guidelines:

1. Gently wipe off any water
2. Open the battery drawer and remove the battery and gently wipe off any water in the battery drawer
3. Let the hearing instrument dry with the battery drawer left open for approximately 30 minutes
4. Insert a new battery

IMPORTANT NOTICE

Do not wear your hearing instrument while showering or participating in water activities. Do not immerse your hearing instrument in water or other liquids.

Conditions of use

Operating conditions	Temperature: +1°C to +40°C Relative humidity: 5% to 93%, non-condensing
Storage and transportation conditions	Temperature and humidity should not exceed the following limits for extended periods during transportation and storage: Temperature: -25°C to +60°C Relative humidity: 5% to 93%, non-condensing

Warranty certificate

Name of owner: _____

Hearing care professional: _____

Hearing care professional address: _____

Hearing care professional phone: _____

Purchase date: _____

Warranty period: _____ Month: _____

Model left: _____ Serial no.: _____

Model right: _____ Serial no.: _____

International warranty

Your hearing aid is covered by an international limited warranty issued by the manufacturer for a period of 12 months from the date of delivery. This limited warranty covers manufacturing and material defects in the hearing aid itself, but not accessories such as batteries, tubing, ear wax filters etc. Problems arising from improper handling or care, excessive use, accidents, repairs made by an unauthorised party, exposure to corrosive conditions, physical changes in your ear, damage due to foreign objects entering the device, or incorrect adjustments are NOT covered by the limited warranty and may void it. The above warranty does not affect any legal rights that you might have under applicable national legislation governing sale of consumer goods. Your hearing care professional may have issued a

warranty that goes beyond the clauses of this limited warranty. Please consult him/her for further information.

If you need service

Take your hearing aid to your hearing care professional, who may be able to sort out minor problems and adjustments immediately.

Technical information

The hearing aid contains a radio transmitter using short range magnetic induction technology working at 3.84 MHz. The magnetic field strength of the transmitter is very weak and always below 15 nW (typically below -40 dB μ A/m at 10 meter distance).

The hearing aid complies with international standards concerning radio transmitters, electro-magnetic compatibility and human exposure.

Due to the limited space available on the instruments all relevant approval markings are found in this document.

USA and Canada

The hearing aid contains a radio module with the following certification ID numbers:

FCC ID: U28FU2BTERIT
IC: 1350B-FU2BTERIT

The device complies with Part 15 of the FCC Rules and with Industry Canada's licence-exempt RSSs.

Operation is subject to the following two conditions:

1. This device may not cause harmful interference.
2. This device must accept any interference received, including interference that may cause undesired operation.

Changes or modifications not expressly approved by the party responsible for compliance could void the user's authority to operate the equipment.

More information: www.oticon.global

This Class B digital apparatus complies with Canadian ICES-003.

Note: This equipment has been tested and found to comply with the limits for a Class B digital device, pursuant to part 15 of the FCC Rules. These limits are designed to provide reasonable protection against harmful interference in a residential installation. This equipment generates, uses and can radiate radio frequency energy and, if not installed and used in accordance with the instructions, may cause harmful interference to radio communications. However, there is no guarantee that interference will not occur in a particular installation. If this equipment does cause harmful interference to radio or television reception, which can be determined by turning the equipment off and on, the user is encouraged to try to correct the interference by one or more of the following measures:

- Reorient or relocate the receiving antenna.
- Increase the separation between the equipment and receiver.
- Connect the equipment into an outlet on a circuit different from that to which the receiver is connected.
- Consult the manufacturer or an experienced radio/TV technician for help.

The manufacturer declares that this hearing aid is in compliance with the essential requirements and other relevant provisions of Directive 2014/53/EU.

Declaration of Conformity is available from the manufacturer.



Manufactured by:
Oticon A/S
Kongebakken 9
DK-2765 Smørum
Denmark
www.oticon.global

CE 0543







Waste from electronic equipment must be handled according to local regulations.

Complies with
IMDA Standards
DA103820







Description of symbols used in this booklet

	Warnings Text marked with a warning symbol must be read before using the device.
	Manufacturer The device is produced by the manufacturer whose name and address are stated next to the symbol. Indicates the medical device manufacturer, as defined in EU Directives 90/385/EEC, 93/42/EEC and 98/79/EC.
	CE mark The device complies with Medical Device Directive 93/42/EEC. The four digits number indicates the identification of the notified body.
	Electronic waste (WEEE) Recycle hearing aids, accessories or batteries according to local regulations. Hearing aid users can also return electronic waste to their hearing care professional for disposal. Electronic equipment covered by Directive 2012/19/EU on waste and electrical equipment (WEEE).
	Regulatory Compliance Mark (RCM) The device complies with electrical safety, EMC and radio spectrum requirements for devices supplied to the Australian or New Zealand market.
	Singapore IMDA label Indicates that the device complies with the standards and specification published by Info-Communications Media Development Authority (IMDA) and is compatible with the public telecommunication networks in Singapore and does not cause radio frequency interference to other authorized radio-communication networks.

	South Africa ICASA label Indicates that the device has license to be sold in South Africa.
	IP code Indicates the class of protections against harmful ingress of water and particulate matter according to EN 60529:1991/A1:2002. IP5X indicates dust protection. IPX8 indicates the protection against the effects of continuous immersion in water.

Description of symbols used on the regulatory packaging label

	Keep dry Indicates a medical device that needs to be protected from moisture.
	Caution symbol Consult instructions for use for warnings and cautions.
	Catalogue number Indicates the manufacturer's catalogue number so that the medical device can be identified.
	Serial number Indicates the manufacturer's serial number so that a specific medical device can be identified.

Power instrument <input type="checkbox"/> Yes <input type="checkbox"/> No				
Settings overview for your hearing aid				
Left			Right	
<input type="checkbox"/> Yes	<input type="checkbox"/> No	Volume control	<input type="checkbox"/> Yes	<input type="checkbox"/> No
<input type="checkbox"/> Yes	<input type="checkbox"/> No	Program shift	<input type="checkbox"/> Yes	<input type="checkbox"/> No
<input type="checkbox"/> Yes	<input type="checkbox"/> No	Mute	<input type="checkbox"/> Yes	<input type="checkbox"/> No
Volume control indicators				
<input type="checkbox"/> On	<input type="checkbox"/> Off	Beeps at min /max volume	<input type="checkbox"/> On	<input type="checkbox"/> Off
<input type="checkbox"/> On	<input type="checkbox"/> Off	Clicks when changing volume	<input type="checkbox"/> On	<input type="checkbox"/> Off
<input type="checkbox"/> On	<input type="checkbox"/> Off	Beeps at preferred volume	<input type="checkbox"/> On	<input type="checkbox"/> Off
Battery indicators				
<input type="checkbox"/> On	<input type="checkbox"/> Off	Low battery warning	<input type="checkbox"/> On	<input type="checkbox"/> Off

198462UK / 2018.10.23

198462UK / 2018.10.23



oticon
PEOPLE FIRST

198462UK/201810,23