

# | Ponto 3 sound processors Instructions for Use



Ponto™ – The Bone Anchored Hearing System

**oticon**  
MEDICAL

## **Thank you**

We would like to take this opportunity to thank you for selecting a Ponto sound processor. Ponto 3 sound processors are intended to be used to improve the hearing of patients with conductive and mixed hearing losses as well as single-sided deafness. It is designed so that it can be optimised for each individual person. This will help ensure you get the maximum benefit from your sound processor.

The Instructions for Use describe how to use your new sound processor.

Please read through this manual carefully to learn how to get the most out of your sound processor. Pay extra attention to warnings, the important information and the instructions for skin hygiene. Discuss any questions or concerns with your clinic.

# Contents

The Ponto bone anchored hearing system	4	Accessories	23
Instrument view	6	Oticon Medical Streamer	26
Managing the battery	8	Service and repair	29
Turning it ON and OFF or stand-by	10	Compatibility Guide	30
Connection	12	Common problems and their possible solutions	32
Disconnection	13	Manufacturer's warranty	34
Correct position	14	Important information	35
Volume control	16	Regulatory compliance statements	37
Programmes	18	Warnings	40
Sound processor maintenance	20	Symbol clarifications	43
Skin hygiene	21		

## The Ponto bone anchored hearing system

Your Ponto 3 is designed to help you gain improved hearing through direct bone conduction. The sound processor converts sound into vibrations that are transmitted via the abutment and implant through the skull bone to the inner ear. This method works independently of the function of the ear canal and middle ear. Ponto 3 is therefore a possible solution to hearing losses where there is a problem in the outer or middle ear preventing sound from reaching the inner ear.

The sound processor can also pick up sound from one side and transfer it to the inner ear on the opposite side. This makes it suitable for those who are deaf on one side, but have a functioning inner ear on the other side (called unilateral profound sensorineural hearing loss or single-sided deafness).

The sound processor can also be used on a soft band for children or for individuals who are unsuitable for implantation.

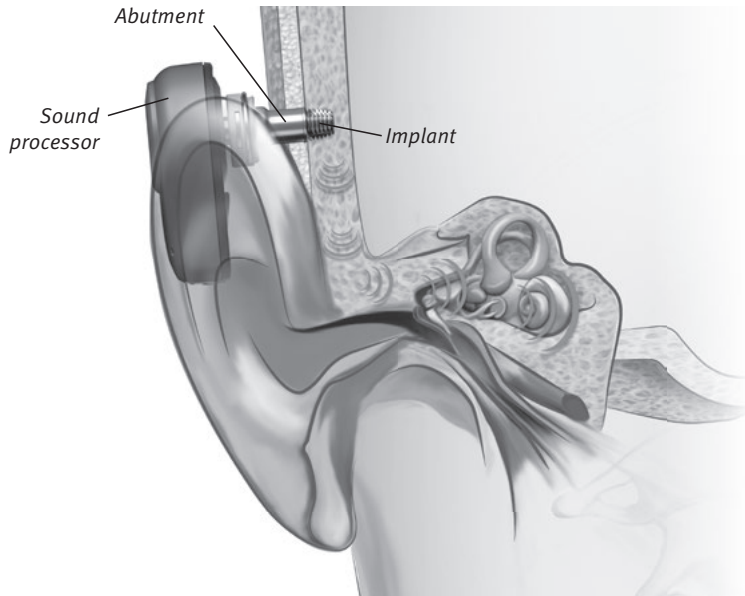

## Instrument view\*

1. Push button for programmes and stand-by/mute
2. Volume control
3. Microphone inlets
4. Programming socket
5. Battery door (on/off, tamper-resistant)
6. Coupling
7. Hole for safety line
8. Labelling

**Right or left version:** Ponto 3 sound processors are available in a left and a right hand version. Each sound processor is marked with an L (left) or R (right) on the battery door for easy identification.

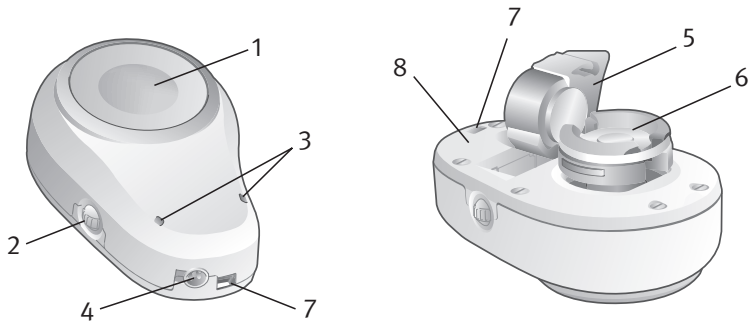

*\*) Picture shows Ponto 3. Instrument view is identical on Ponto 3 Power and Ponto 3 SuperPower.*

## **WARNING**

The sound processor contains small parts that may be a choking hazard for small children. Batteries can also be harmful if swallowed. Always keep batteries out of reach of small children or people of diminished mental capacity. If a battery is accidentally swallowed, seek medical attention at the nearest emergency department.

## Managing the battery

### Battery insertion

Open the battery door and insert the battery with the plus-sign facing downwards on the sound processor. It is very important to insert the battery correctly to avoid damaging the battery compartment.

Ponto 3: Only use high-quality zinc-air batteries, type 13.

Ponto 3 Power: Only use high-quality zinc-air batteries, type 675.

Ponto 3 Super Power: Only use high-quality zinc-air batteries, type 675P, high-power, and cochlear implant hearing aid batteries.

### Tamper-resistant battery door

To lock the battery door: Make sure the door is completely closed. Use the screwdriver in the battery removal tool to turn the tamper-resistant screw to the locked position.

To unlock the battery door: Use the screwdriver in the battery removal tool to turn the tamper-resistant screw to the unlocked position. The battery door can now be opened and closed as usual.





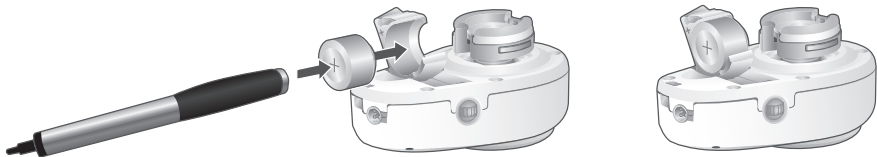

### **Low-battery indicator**

Your sound processor has a low-battery warning system. When it is time to change the battery you will hear two consecutive beeps.

When the battery is completely worn out, this will be indicated by four consecutive beeps. The battery lifetime depends upon the listening environment and the sound processor used.

### **Battery removal**

After the battery door is opened, the battery can be removed. The small magnetic battery removal tool delivered with your sound processor may facilitate battery removal and insertion.

## Turning it ON and OFF or stand-by

### On

Ponto 3 is turned ON by closing the battery door. After a start-up jingle, there is a few seconds' delay before the sound processor is turned on. The delay is designed to avoid a whistling sound while connecting your sound processor to the abutment.

### Off

Ponto 3 is turned **OFF** by opening the battery door. It is enough to open the battery door halfway, which prevents the battery from falling out. During longer storage, it is recommended that you remove the battery from the sound processor.

### Stand-by/Mute

If you want to turn off the sound processor for shorter periods, press the push button and hold until 2 beeps are heard and then release the button. The sound processor will now be in stand-by/mute mode and the volume will be set to zero.

To hear sound again, briefly press and release the push button and the sound processor will resume its previous setting. It is not recommended that you use the stand-by mode for longer periods, i.e. more than 5 hours, since this will reduce the battery lifetime.

Note: The stand-by feature is optional and may sometimes be disabled during the fitting procedure. Talk to your clinic if you have questions.

**On**



**Off**

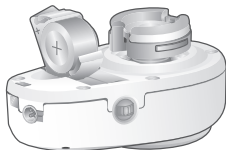

**Stand-by/Mute**



– Press and hold until  
2 beeps are heard



Note: If you have two Ponto 3 sound processors and binaural coordination is enabled (default), when stand-by mode is activated in one sound processor, binaural coordination will also activate stand-by mode in the other sound processor. Binaural coordination can be disabled in Genie Medical.

## Connection

To safely and comfortably connect the sound processor, tilt it slightly and carefully push it onto the abutment. Please note it is important to keep hair out of the way when the sound processor is connected to the abutment.

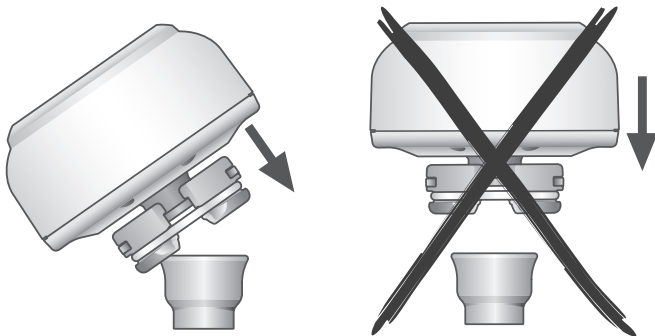

## Disconnection

The sound processor is safely and comfortably disconnected by carefully tilting it away from the abutment.

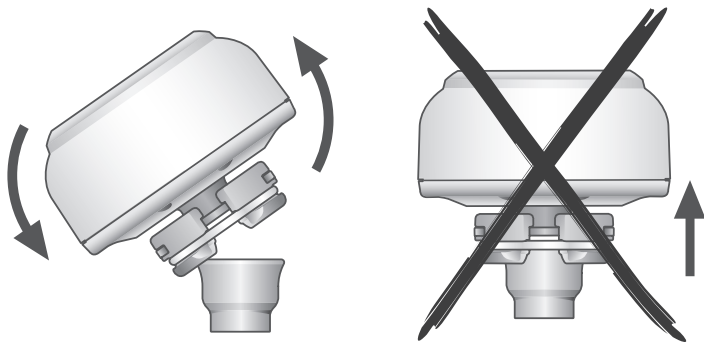

## Correct position

To get optimum performance from the directional microphone system, the sound processor should be positioned vertically with the microphones at the bottom and the volume control facing backwards.

Please note it is important that the sound processor does not touch anything, e.g. the ear, skin or a hat. This can cause feedback (a whistling sound).

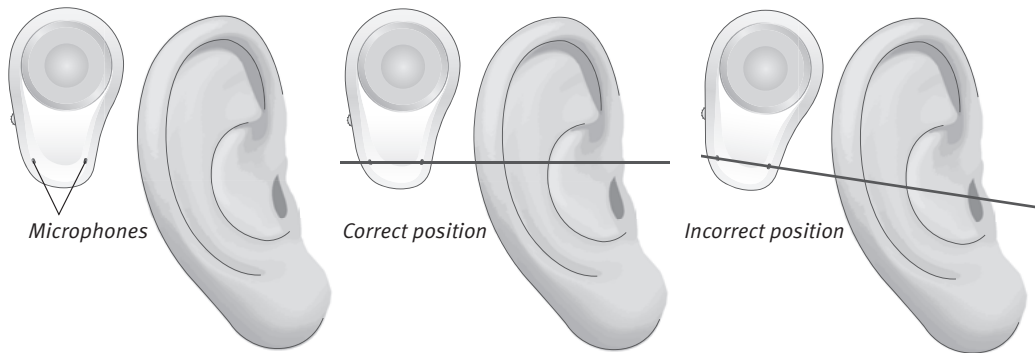

## Volume control

The volume is increased by turning the volume control upwards and decreased by turning it downwards. When the volume control is turned, beeps can be heard to indicate that the volume is being changed. When the maximum or minimum volume has been reached the beeps will cease. Please note it is possible for your hearing care professional to turn off the volume control.

When passing the default start-up volume, 2 beeps are heard. If you have an Oticon Medical Streamer (page 26) you can use this as a remote control to adjust the volume in the sound processor.

**Note:** If you have two Ponto 3 sound processors and binaural coordination is enabled (default), when the volume control is adjusted on one sound processor, the volume on the other sound processor will also be affected. Binaural coordination can be disabled in Genie Medical.





## Programmes





With the push button you can put your sound processor in stand-by mode or change the listening programme. By default, your sound processor has one programme; your hearing care professional can define more.

To change the programme, simply press and release the push button. The next programme will be indicated by a corresponding number of beeps. Please note the sound processor will go into stand-by mode if the push button is held for more than 2 seconds.

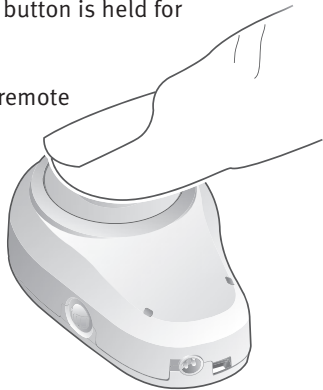
If you have an Oticon Medical Streamer you can use it as a remote control to change programmes in your sound processor.

**Change programme** – Briefly press and release the button



Programme	Beeps	Description
1		
2		
3		
4		

Ask your clinic for information on programmes to fill out this programme chart.

Note: If you have two Ponto 3 sound processors and binaural coordination is enabled (default), when the programme is changed with the push button on one sound processor, this will also change the programme on the other. Binaural coordination can be disabled in Genie Medical.

## Sound processor maintenance

A dry cloth or baby wipe may be used to clean the outside of the sound processor. Special attention should be given to the coupling to remove any dirt or entangled hair.

Please note no water or liquids should be used when cleaning your sound processor – it is not waterproof. If the sound processor accidentally gets wet, open the battery door and let the sound processor dry.

It is important to protect or remove your sound processor during visits to the hairdresser and when applying hair products. You may use the special abutment cover provided with your sound processor to protect your abutment.

The sound processor is programmed to fit you personally and therefore it should not be used by others.

# Skin hygiene

## Daily cleaning

In order to reduce the risk of skin infections around the abutment, it is important to maintain a good daily cleaning routine.

Before the skin has fully healed, antibacterial soap and non-alcohol baby wipes may be used to clean the area around the abutment.

When healing has progressed, you should start using a cotton swab or a soft brush. Use the brush on a daily basis, together with soap and water, to gently clean the outside and inside of the abutment.

The brush should be replaced about once every 3 months. Only very soft brushes should be used. If you have two implants, you should use two soft brushes – one for each abutment. Soft brushes, like the one pictured, can be purchased from Oticon Medical. Ask your clinic for more information.



### **Cleaning every few days**

In addition to the daily cleaning routines, the skin should be cleaned more thoroughly to remove debris at least twice a week. During hair washing, debris becomes softer and is easier to remove. The cleaning brush should still be used with care.

If you have persistent problems with soreness surrounding the abutment, contact your ear clinic. Parents or caregivers are responsible for maintaining good hygiene around a child's abutment.

Please note it is essential to clean both the inside and outside of the abutment. This is important to prevent debris build-up.

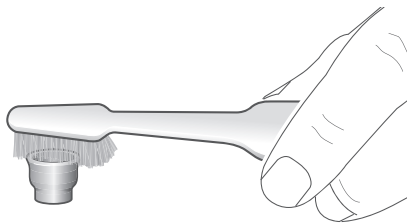

## Accessories

### Safety line

The safety line is designed to help you avoid dropping your sound processor during physical activity or in other situations where there is a risk that the device may fall off. To avoid dropping your sound processor, attach the safety line to the sound processor and the clip to your clothing. We also recommend that you use the safety line at first when you are getting used to wearing the device.

Please make sure the safety line is not pulled, as the sound processor may then become disconnected from the abutment.

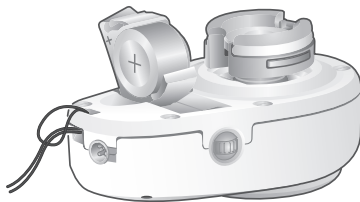

### **Abutment cover**

The abutment cover can be connected to the abutment when the sound processor is not being used. This prevents dirt from getting into the abutment and also conceals the abutment.



### **Test rod**

The test rod allows you to listen to the sound processor without connecting it to an abutment. Connect your Ponto 3 to the test rod and press it against your head to listen to the sound processor. This is also useful for demonstrating and testing your sound processor for your friends and family. Please note your hand must not touch the sound processor when holding the rod since this will cause feedback (whistling sound).

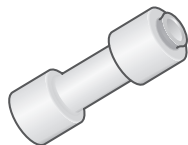



## **Stickers**

The stickers give you the opportunity to adapt the appearance of your sound processor. How to apply and remove the stickers:

1. Place the round sticker on the push button so it sticks to the push button area.
2. Place the lower part of the sticker on the sound processor. Please make sure it does not cover the microphone inlets.

To avoid air bubbles, start in the centre and press gently towards the outer edges of the stickers.

Use your fingernail to remove the sticker. Do not use sharp objects as they may damage the sound processor.

## **Skins**

The skin allows you to change the look of your sound processor. Please make sure it is attached properly so that it does not cover the microphone inlets and the volume control can be freely operated. The skins are available in a range of colours. Please ask your clinic for more information.

## Oticon Medical Streamer\*

The Oticon Medical Streamer allows you to wirelessly connect your Ponto 3 sound processor to different audio sources and transmit the sound from the source to your sound processor.

The Oticon Medical Streamer also acts as a remote control for your sound processor. It is worn around the neck and features three buttons for core applications: phone, TV and microphone.

Ponto 3 sound processors are compatible with the Oticon Medical Streamer.

*\*Please note that the Oticon Medical Streamer and products shown on pages 26-28 are optional accessories. Please contact your clinic or visit [www.oticonmedical.com/connectline](http://www.oticonmedical.com/connectline) for more information about the Oticon Medical Streamer and its possibilities.*





### **Mobile phone**

The Oticon Medical Streamer can be connected to a broad range of mobile phones with built-in Bluetooth and thereby transmit mobile phone sound wirelessly to the sound processor. This transforms the sound processor into a personal wireless headset. A list of compatible mobile phones is available at [www.oticonmedical.com/connectline](http://www.oticonmedical.com/connectline).



### **Music**

Music can be listened to by connecting an MP3 player to the Oticon Medical Streamer by using either a cable or Bluetooth wireless connection.



### **Tele loop**

The Oticon Medical Streamer has a built-in telecoil designed to improve sound quality and speech understanding within rooms that have a tele loop installed. Loop facilities are available in many public buildings such as theatres, cinemas, lecture halls, schools and similar locations. The telecoil in the Oticon Medical Streamer picks up the signal from the tele loop and transmits the sound to Ponto 3.



### **Remote control**

The Oticon Medical Streamer also acts as a remote control for your sound processor and is an easy way to change the programme or adjust the volume.



### **FM**

An FM system consists of an FM receiver and a transmitter. The receiver is connected to the Euro pin socket on the Oticon Medical Streamer and is used to pick up low-power radio signals from the transmitter. FM systems are used, for example, in schools to support hearing-impaired children. The teacher wears an FM transmitter, which sends signals directly to Ponto 3 via the FM receiver and the Oticon Medical Streamer.



### **TV, landline telephone and microphone**

The Oticon Medical Streamer can be combined with different ConnectLine products from Oticon (ConnectLine TV, ConnectLine phone, ConnectLine microphone) to offer dedicated solutions for watching TV, using the landline phone and listening to another person through a microphone.



## Service and repair

If your Ponto 3 sound processor does not function properly, contact your clinic to get it checked.

Contact person at Audiology Clinic – name and contact information:

---

---

---

Contact person at ENT Clinic – name and contact information:

---

---

---

## Compatibility Guide

Description	Article
<b>Abutments in Oticon Medical Ponto implant system</b>	All
<b>Oticon Medical accessories</b>	Genie Medical (Fitting software, version 2011.1 or later)
	Ponto Softband
	SoundConnector
	Test band
	Head band
	Xpress
<b>Oticon A/S accessories</b>	FM receiver Amigo R2BA (through Oticon Medical Streamer only)
	Oticon Medical Streamer

## Compatibility Guide

Description	Article
<b>Compatible products from Cochlear BAS</b>	Baha® abutments (90305, 90410)
	Baha® implants with abutment (90434, 90480)
	Baha® audio adapter (90065)
	Baha® telecoil unit (90185)
<b>Incompatible products from Cochlear BAS</b>	Baha® BA300 Series abutments
	Baha® BA210 Series abutments
	Baha® BA400 Series abutments
<b>Phonak AG accessories</b>	Phonak FM system Inspiro transmitter
	Phonak MlxiBA receivers

## Common problems and their possible solutions

<b>Symptom</b>	<b>Possible causes</b>
<b>No sound</b>	Worn-out battery
	Sound processor is on stand-by (mute)
<b>Intermittent or reduced sound</b>	Dirt in the coupling or sound inlet
	Moisture
	Worn-out battery
<b>Whistling noise</b>	Sound processor is touching something



<b>Solutions</b>	
Change battery	pages 8-9
Press push button	pages 10-11
Clean the sound processor	page 20
Open the battery door and let the sound processor dry out in its case	page 20
Change battery	pages 8-9
Check that the sound processor is correctly connected and is not touching anything	pages 12-15

If none of the above solutions solve the problem, please contact your clinic for assistance.

## Manufacturer's warranty

Oticon Medical sound processors are covered by a limited warranty issued by the manufacturer for a period of 12 months from the date of delivery. This limited warranty covers manufacturing and material defects in the hearing instrument itself, but not batteries.

Problems arising from improper handling or care, excessive use, accidents, repairs carried out by an unauthorised party, exposure to corrosive conditions, damage due to foreign objects entering the device, or incorrect adjustments are NOT covered by the limited warranty and may void the warranty.

The above warranty does not affect any legal rights that you might have under applicable national legislation governing the sale of consumer goods. Your clinic may have issued a warranty that goes beyond the clauses of this limited warranty. Please consult clinic for further information.

If you have any comments or suggestions related to the Oticon Medical bone anchored hearing system, please use the e-mail address on the back of the manual to contact us.

## Important information

- It is important to follow the skin hygiene guidelines. Please contact your ear clinic if you have questions or concerns.
- Always keep your sound processor in its box when it is not being worn so that it is protected from dust and dirt. If you are using a skin, please make sure you remove the skin before putting the sound processor in its box.
- Whenever the sound processor is not in use, ensure it is switched off by opening the battery door. The battery door should be left open so that any moisture in the sound processor is allowed to evaporate.
- If you are not wearing the Oticon Medical Streamer when using a telephone, please hold the receiver of the telephone close to the sound processor. To avoid feedback (a whistling sound), make sure the telephone does not touch the sound processor. (For more information on the possibilities of the Oticon Medical Streamer, see pages 26-28.)
- The expected service life of the sound processor is 5 years.

- To avoid setting off metal detectors when travelling, your sound processor can be removed before passing through the security controls.
- **Operating conditions**  
Temperature: +1°C to +40°C  
Relative humidity: 5% to 93%, non-condensing
- **Storage and transportation conditions**  
Temperature and humidity should not exceed the following limits for extended periods during transportation and storage.  
Temperature: -25°C to +55°C  
Relative humidity: 5% to 93%, non-condensing
- The power source in your sound processor has insufficient energy to cause fire in normal conditions of use. The sound processor has not been tested for compliance with international standards concerning explosive atmospheres. It is recommended not to use your sound processor in areas where there is a danger of explosion.

## Regulatory compliance statements

Operation is subject to the following two conditions:

1. This device may not cause harmful interference.
2. This device must accept any interference received, including interference that may cause undesired operation.

Changes or modifications not expressly approved by the party responsible for compliance could void the user's authority to operate the equipment.

*NOTE: This equipment has been tested and found to comply with the limits for a Class B digital device, pursuant to Part 15 of the FCC rules.*

*These limits are designed to provide reasonable protection against harmful interference in a residential installation. This equipment generates, uses and can radiate radio frequency energy and, if not installed and used in accordance with the instructions, may cause harmful interference to radio communications. However, there is no guarantee that interference will not occur in a particular installation.*

*If this equipment does cause harmful interference to radio or television reception, which can be determined by turning the equipment off and on, the user is encouraged to try to correct the interference by one or more of the following measures:*

- *Reorient or relocate the receiving antenna.*
- *Increase the distance between the equipment and the receiver.*
- *Connect the equipment to an outlet on a circuit different from that to which the receiver is connected.*
- *Consult the dealer or an experienced radio/TV technician for help.*

The legal manufacturer hereby declares that this Ponto 3 is in compliance with the essential requirements and other relevant provisions of the Radio Equipment Directive 2014/53/EU. Declaration of conformity is available at: Oticon Medical AB



Equipment  
includes  
RF transmitter



The Ponto 3 contains a radio transmitter using short-range magnetic induction technology, working at 3.84 MHz. The magnetic field strength of the inductive transmitter is  $< -15 \text{ dB}\mu\text{A/m @ 10m}$ .

The emission power from the Ponto 3 is below international emission limits for human exposure. The Ponto 3 complies with international standards concerning electromagnetic compatibility.

Due to the limited size available on the device, many of the relevant approval markings are found in this document.

FCC ID: 2AHJWPONTO3

IC: 21199-PONTO3

The device complies with Part 15 of the FCC rules and RSS-210 of Industry Canada.

## **WARNINGS**

- The sound processor, batteries, parts and accessories are not toys and should be kept out of reach of children and anyone who might swallow these items or otherwise cause injury to themselves. The sound processor contains small parts that may be a choking hazard for small children.
- If you drop the sound processor, make sure the shell is not cracked or any parts of the sound processor have broken. If you find something wrong with your sound processor please contact Oticon Medical.
- Never dispose of your sound processor, its parts or batteries by burning them. There is a risk that they will explode and cause serious injury.
- Although the sound processor has achieved IP57 classification it is referred to as being water resistant, not waterproof. Always disconnect the sound processor before showering or bathing/swimming. If the sound processor accidentally gets wet, open the battery door and take out the battery to let the sound processor dry.
- Avoid exposing the sound processor to extreme heat.





- Electromagnetic interference may occur in the vicinity of equipment with the symbol to the right. Portable and mobile RF (radio frequency) communications equipment can affect the performance of your sound processor. If your sound processor is affected by electromagnetic interference, move away from the source to reduce the interference.
- Although unlikely, nearby electronic devices may be affected by your sound processor. In that case, move the sound processor away from the affected electronic device.
- The sound processor is MR Unsafe. If you need to undergo MRI (Magnetic Resonance Imaging) the sound processor must be disconnected. The implant and the abutment can remain in place. When scheduling and visiting the location of your MRI be sure to inform the doctor or technician that you have a bone anchored system (for children and mentally disabled persons this responsibility falls to the caregiver).
- The sound processor contains a magnet. Caution must be taken with programmable CSF shunts. Follow the guidelines for required minimum distance recommended by the shunt manufacturer.

### **Battery use**







- Always use the batteries recommended in this manual. Batteries of low quality may leak and cause bodily harm.
- Batteries can be harmful if swallowed. Always keep batteries out of reach of small children or people of diminished mental capacity. If a battery is accidentally swallowed, seek medical attention at the nearest emergency department.





### **Dysfunction in sound processors**

- The sound processor may stop functioning, for instance if the batteries are worn out. You should be aware of this possibility, in particular when you are in traffic or otherwise dependent on warning sounds.

### **Possible side effects**

- The otherwise non-allergenic materials used in sound processors may in rare cases cause skin irritation. Consult a doctor if you experience any side effects.

<b>Symbol clarifications</b>	
	Reference number
	Serial number
	Manufacturer
	Date of manufacture
	Consult instructions for use
	Caution. Consult instructions for use for warnings and precautions that are not found in the device itself
Rx Only	RX Only Caution: Federal law (USA) restricts this device to sale by or on the order of a licensed medical practitioner
 0413	CE mark with notified body number

	Waste from electronic equipment must be handled according to local regulations
	Type B Applied part
	IP Code classifies and rates the degrees of protection provided against the intrusion of solid objects (including body parts like hands and fingers), dust, accidental contact, and water in mechanical casings and with electrical enclosures
YY.XXXXXXXX	The two first digits in the serial number “YY” indicate the year of manufacturing.
	Regulatory compliance mark for ACMA (Australian Communications and Media Authority)
	Keep away from small children to reduce the risk of accidental swallowing, choking and strangulation.

**For USA only:** Federal law restricts this device to sale by or on the order of a medical practitioner.

A prospective user of a bone anchored sound processor should always have a medical evaluation by a licensed physician to ensure that all medically treatable conditions that may affect hearing are identified and treated before a sound processor is purchased.

CE 0413





*Manufacturer:*

**Oticon Medical AB**

Datavägen 37B

SE-436 32 Askim

Sweden

Phone: +46 31 748 61 00

[info@oticonmedical.com](mailto:info@oticonmedical.com)

M52611UK / 2020.11

**oticon**  
MEDICAL

Because  
sound matters



0000M5261100001

[www.oticonmedical.com](http://www.oticonmedical.com)